

EC Declaration of Conformity

We

GOOD WILL INSTRUMENT CO., LTD.

(1) No. 95-11, Pao-Chung Rd., Hsin-Tien City, Taipei Hsien, Taiwan
 (2) Plot 522, Lorong Perusahaan Baru 3, Prai Industrial Estate, 13600 Prai, Penang, Malaysia

declares that the below mentioned product

GFG-8215A, GFG-8216A, GFG-8217A, GFG-8219A, GFG-8250A, GFG-8255A are herewith confirmed to comply with the requirements set out in the Council Directive on the Approximation of the Law of Member States relating to Electromagnetic Compatibility (89/366/EEC, 92/31/EEC, 93/68/EEC) and Low Voltage Equipment Directive (73/23/EEC).

For the evaluation regarding the Electromagnetic Compatibility and Low Voltage Equipment Directive, the following standards were applied:

TABLE OF CONTENTS

1.	SAFETY SUMMARY	1
2.	INTRODUCTION.....	5
3.	SPECIFICATION.....	7
4.	FUNCTION DESCRIPTION.....	13
5.	USAGE DESCRIPTION.....	17
6.	APPLICATION NOTE.....	23
7.	MAINTENANCE.....	33

EN 61326-1: Electrical equipment for measurement, control and laboratory use — EMC requirements (1997+A1: 1998)	
Conducted and Radiated Emissions EN 55011 Group I class A: 1991	Electrostatic Discharge EN 61000-4-2: 1994
Current Harmonic EN 61000-3-2: 1995	Radiated Immunity ENV 50140: 1993
Voltage Fluctuation EN 61000-3-3: 1995	Electrical Fast Transients EN 61000-4-4: 1995
	Surge Immunity EN 61000-4-5: 1995
	Conducted Susceptibility EN 61000-4-6: 1996
	Power Frequency Magnetic field EN 61000-4-8: 1993
	Voltage Dips/ Interrupts EN 61000-4-11: 1994

Low Voltage Equipment Directive 73/23/EEC & amended by 93/68/EEC
Safety Requirements EN 61010-1: 1990+A1: 1992+A2: 1995; IEC 61010-1: 1990+A1: 1992+A2: 1995

1.SAFETY TERMS AND SYMBOLS

Please take a moment to review these safety terms and symbols which may appear in this manual or on Equipment to prevent damage to the Function Generators.



WARNING. Warning statements identify condition or practices that could result in injury or loss of life.



CAUTION. Caution statements identify conditions or practices that could result in damage to this product or other property.



DANGER High Voltage



ATTENTION refer to Manual



Protective Conductor Terminal



(ground) Earth Terminal



Frame or Chassis Terminal

FOR UNITED KINGDOM ONLY

NOTE: This lead/appliance must only be wired by
competent persons

WARNING: THIS APPLIANCE MUST BE EARTHED

IMPORTANT: The wires in this lead are coloured in
accordance with the following code:

Green/ Yellow: Earth
Blue: Neutral
Brown: Live(Phase)

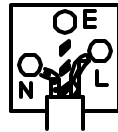

As the colours of the wires in main leads may not correspond with the colours marking identified in your plug/appliance, proceed as follows:

The wire which is coloured Green & Yellow must be connected to the Earth terminal marked with the letter E or by the earth symbol  or coloured Green or Green & Yellow.

The wire which is coloured Blue must be connected to the

terminal which is marked with the letter N or coloured Blue or Black.

The wire which is coloured Brown must be connected to the terminal marked with the letter L or P or coloured Brown or Red.

If in doubt, consult the instructions provided with the equipment or contact the supplier.

This cable/appliance should be protected by a suitably rated and approved HBC mains fuse : refer to the rating information on the equipment and/or user instructions for details. As a guide, cable

of 0.75mm^2 should be protected by a 3A or 5A fuse. Larger conductors would normally require 13A types, depending on the connection method used.

Any moulded mains connector that requires removal /replacement must be destroyed by removal of any fuse & fuse carrier and disposed of immediately, as a plug with bared wires is hazardous if engaged in live socket. Any re-wiring must be carried out in accordance with the information detailed on this label.

2. INTRODUCTION

The Function Generator series are stable low distortion instruments which generate signals in the frequency range up to 5MHz. Typical applications include a wide range of audio response testing applications, vibration testing, servo system evaluation, ultra sound applications, and etc.

These instruments include the following features: logarithmic and linear sweep capabilities, together with a built in frequency counter. The sweep capability simplifies the task of finding resonant points of speakers, filter networks and other networks/structures. An oscilloscope may be connected to this instrument for the response to be displayed. The counter can be switched to measure and display the frequency of an external signal up to 150MHz.

● ADDITIONAL FEATURES

- 1.Low distortion waveforms (sine, triangular and square) and ramp signal.
- 2.Signal output in seven decade stages, 0.5Hz to 5MHz for GFG -8250A/8255A, 0.3Hz to 3MHz for GFG-8215A/8216A/8217A/8219A.
- 3.Adjustable sweep time and sweep width both in linear and logarithmic modes.
- 4.Duty cycle control with signal inversion capability.
- 5.External Voltage controlled Frequency (VCF).
- 6.AM or FM modulation modes with internal or external modulation control.

- 7.A second output for TTL or adjustable CMOS pulses.
- 8.50 ohm main signal output with DC offset adjustment and 20dB attenuation capability.
- 9. Supplied with two BNC test leads and AC power cord set.

● **FEATURES COMPARISON TABLE FOR MODELS:**

MODEL FEATURE	GFG-8215 A	GFG-8216 A	GFG-8217 A	GFG-8219 A	GFG-8250 A	GFG-825 5A
AM/FM				✓		✓
SWEEP			✓	✓		✓
COUNTER		✓	✓	✓	✓	✓
GCV Output				✓	✓	✓
TTL/CMOS	✓	✓	✓	✓	✓	✓
VCF	✓	✓	✓	✓	✓	✓
Duty Cycle Control	✓	✓	✓	✓	✓	✓

3. SPECIFICATION

	GFG-8215A/8216A/8217A/8219A	GFG-8250A/8255AA
1.Main		
Frequency Range	0.3Hz 3MHz(7 Range)	0.5Hz 5MHz(7 Range)
Amplitude	10Vpp(into 50 load)	10Vpp(into 50 load)
Impedance	50 ±0%	50 ±0%
Attenuator	-20dB ±dB ∞	-20dB ±dB ∞
DC Offset	< -5V > 5V (into 50 load)	< -5V > 5V (into 50 load)
Duty Control	80%:20%:80% to 1MHz Continued variable	80%:20%:80% to 1MHz Continued variable
Display	6 digits LED display *GFG -8215A does not have display.	6 digits LED display
Range Accuracy	±%+1Hz(at 3.0 position) *only for GFG-8215A.	-----
2.Sine Wave		
Distortion	1%,0.3Hz 200kHz THD 35dB below fundamental in all range (Specification applied from MAX. to 1/10 level)	1%,0.5Hz 100kHz THD 30dB below fundamental in all range (Specification applied from MAX. to 1/10 level)
Flatness	< 0.3dB,0.3Hz 300kHz < 0.5dB,300kHz 3MHz	0.3dB,below 500kHz 1dB,below 5MHz
3.Triangle Wave		
Linear	98%,0.3Hz 100kHz 95%,100kHz 3MHz	98%,0.5Hz 100kHz 95%,100kHz 5MHz
4.Square Wave		
Symmetry	±%,0.3Hz 100kHz	±%,1Hz 100kHz
Rise or Fall Time	100ns at maximum output. (into 50 load)	50ns at maximum output (into 50 load)

	GFG- 8215A/8216A/8217A/8219A	GFG- 8250A/8255A
5.CMOS Output		
Level	4Vpp \pm Vpp 14.5Vpp \pm 0.5Vpp adjustable	4Vpp \pm Vpp 14.5Vpp \pm 0.5Vpp adjustable
Rise or Fall Time	120ns	120ns
6.TTL Output		
Level	3Vpp	3Vpp
Fan Out	20 TTL load	20 TTL load
Rise or Fall Time	25ns	25ns
7.VCF		
Input voltage	0V 10V \pm V(100:1)	0V 10V \pm V(100:1)
Input Impedance	10k \pm 0%	10k \pm 0%
8.GCV(for GFG-8219A/8255A only)		
Output voltage	To set the voltage between 0V 2V as per different frequency.	To set the voltage between 0V 2V as per different frequency.
9.Sweep Operation(for GFG-8217A/8219A/8255A only)		
Sweep/Manual	Switch selector	Switch selector
Sweep/Rate	100:1 ratio max. and adjustable	100:1 ratio max. and adjustable
Sweep/Time	0.5Sec 30Sec adjustable	0.5Sec 30Sec adjustable
Sweep/Mode	Lin./Log. switch selector	Lin./Log. switch selector
10.Amplitude Modulation(for GFG-8219A/8255A only)		
Depth	0 100%	0 100%
MOD.Freq.	400Hz(INT),DC 1MHz(EXT)	400Hz(INT),DC 1MHz(EXT)
Carrier BW	100Hz 3MHz(-3dB)	100Hz 5MHz(-3dB)
EXT Sensitivity	10Vpp for 100% modulation	10Vpp for 100% modulation

	GFG- 8215A/8216A/8217A/8219A	GFG- 8250A/8255A
11.Frequency Modulation (for GFG-8219A/8255A only)		
Deviation	0 \pm 5%	0 \pm 5%
MOD.Freq.	400Hz(INT),DC 20kHz(EXT)	400Hz(INT),DC 20kHz(EXT)
EXT Sensitivity	10Vpp for 10% modulation	10Vpp for 10% modulation
12.Frequency Counter		
Int./Ext.	Switch selector	Switch selector
Range	0.3Hz 3MHz (5Hz 150MHz EXT)	0.5Hz 5MHz (5Hz 150MHz EXT)
Accuracy	time base accuracy \pm count	Time base accuracy \pm count
Time base	\pm 20ppm(23 \pm) after 30 minutes warm up	\pm 20ppm(23 \pm) after 30 minutes warm up
Resolution	The maximum resolution is 100nHz for 1Hz and 1Hz for 100MHz.	The maximum resolution is 100nHz for 1Hz and 1Hz for 100MHz.
Input Impedance	1M /150pF	1M /150pf
Sensitivity	35mVrms(5Hz~100MHz) 45mVrms(100MHz~150MHz) *GFG -8215A does not have Frequency Counter function.	35mVrms(5Hz~100MHz) 45mVrms(100MHz~150MHz)
13.General		
Power Source	AC115V, 230V \pm 5%.50/60Hz	AC115V, 230V \pm 5%.50/60Hz
Operation Environment	Indoor use, altitude up to 2000m. Ambient Temperature 0 to 40 . Relative Humidity 80%(Maximum). Installation category II Pollution Degree 2	
Storage temperature & Humidity	-10 to 70 . 70% (Maximum).	

	GFG- 8215A/8216A/8217A/8219A	GFG- 8250A/8255A
Accessories	GT L-101 ✕ *GTL-101 ✕ for GFG-8215A. Instruction manual ✕	GT L-101 ✕ Instruction manual ✕
Dimension	251(W) ✕91(H) ✕91(D)m/m	251(W) ✕91(H) ✕91(D) m/m
Weight	Approx. 2.0kgs- GFG-8215A 2.1kgs- GFG-8216A 2.15kgs- GFG-8217A 2.2kgs- GFG-8219A	Approx. 2.3kgs- GFG-8250A 2.4kgs- GFG-8255A

! WARNING? To avoid electrical shock, the power cord protective grounding conductor must be connected to ground.

! CAUTION? To avoid damaging the instrument, do not use it in a place where ambient temperature exceeds 40 .

! CAUTION? To avoid damaging the instrument, do not input more than DC15V to V.C.F.(V.C.G.).

! CAUTION? To avoid damaging the instrument, do not input more than AC150V to Frequency Counter (for GFG-8216A, GFG-8217A, GFG-8219A, GFG-8250A, and GFG-8255A).

! CAUTION? To avoid damaging the instrument, do not input more than AC10Vpp when proceed EXT modulation operation (for GFG -8219A, GFG-8255 A).

● Fig 4.1 FRONT PANEL

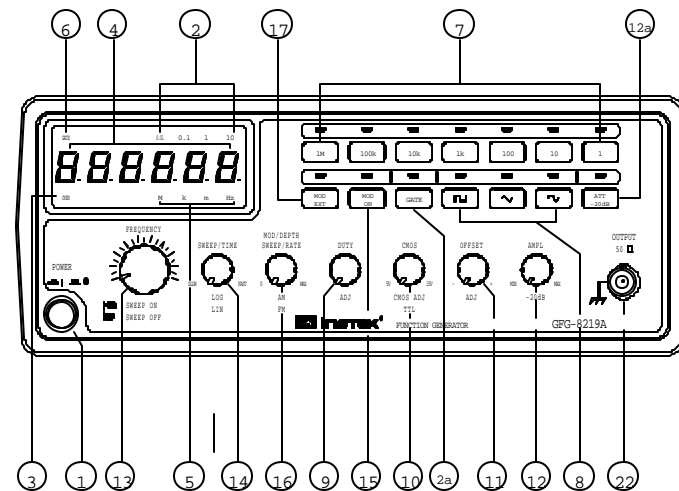

● Fig.4-2 REAR PANEL

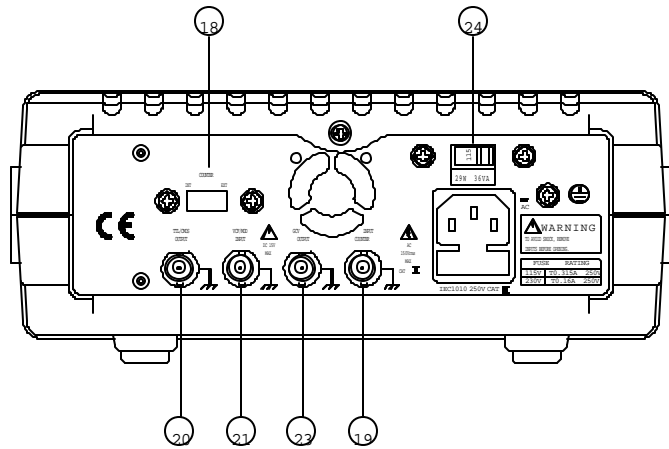

4. FUNCTION DESCRIPTION

1. Power Switch Connect the AC power, then press power switch.
2. Gate Time Indicator Press the power switch, Gate time indicator will start to flash (the gate time of internal counter is 0.01 second).
- 2a. Gate Time Selector Press this key to change gate time when use external counter mode. The change order is according to 0.01s, 0.1s, 1s,10s cycle by pressing these keys.
3. Over Indicator In the external counter mode, the indicator is illuminated when the output frequency is greater than the range selected.
4. Counter Display Shows the external frequency by $6 \times 0.3''$ green display, and shows the internal frequency by 5×0.3 green display.
5. Frequency Indicator Indicate the current frequency value.
6. Gate Time Indicator Indicate the current Gate time (external. counter mode use only).
7. Frequency Range Selector To select the required frequency range by pressing the relevant push button on the panel as shown in Table 1 and Table 2.

Table 1(for GFG-8215A/8216A/8217A/8219A)

Push bottom	1	10	100	1k	10k	100k	1M
Frequency Range	0.3Hz	3Hz	30Hz	300Hz	3kHz	30kHz	300kHz
	3Hz	30Hz	300Hz	3kHz	30kHz	300kHz	3MHz

Table 2(for GFG-8250A/8255A)

Push bottom	1	10	100	1k	10k	100k	1M
Frequency Range	0.5Hz	5Hz	50Hz	500Hz	5kHz	50kHz	500kHz
	5Hz	50Hz	500Hz	5kHz	50kHz	500kHz	5MHz

8. Function Selector Press one of the three push buttons to select the desired output waveform.
9. Duty Function Pull out and rotate the knob to adjust the duty cycle of the waveform.
10. TTL/CMOS Selector When push in the knob, the BNC terminal of ⑳ will output a TTL compatible waveform. If pull out and rotate the knob can adjust the CMOS compatible output (5-15Vpp) from the output of BNC ㉑ .
11. DC Offset Control Pull out the knob to select any DC level of the waveform between $\pm 10V$, turn clockwise to set a positive DC level waveform and invert for a negative DC level waveform.
12. Output Amplitude Control with Attenuation Operation Turn clockwise for MAX. output and invert for a -20dB output. Pull the knob out for an additional 20dB output attenuation.

- 12a. 20dB Attenuation Press the knob to adjust a -20dB output.
13. MANU/SWEEP Selector and Frequency Adjustment (Sweep On/Off) Press and turn clockwise the knob for MAX frequency and invert for MIN frequency. (Keep the pointer within the scale range on the panel.). Pull out the knob to start the auto sweep operation; the upper frequency limit is determined by the knob position.
14. Sweep Time Control and LIN/LOG Selector (1) Rotate the knob clockwise to adjust sweep time for MAX, or invert for MIN.
(2) To proceed Linear sweep mode by pushing in the knob, or select LOG sweep mode by pulling out the knob.
15. Control MOD ON/OFF Selector Pull out the knob, the output can be modulated by internal 400Hz Sine wave or an external signal via CVF/MOD in connector ㉑.
16. Sweep Width & Modulation Carrier &AM/FM Selector &FM Selector (1) Sweep width can be controlled from 0 to 1000times.
(2) To adjust modulation ratio by turning the knob clockwise for MAX, or invert for MIN.
(3) Press the knob to get AM function or pull it out for FM function.
17. INT/EXT MOD Selector When press the button once, the indicator will lighten, then the EXT MOD has been selected. Press the key again, the indicator will be off, then INT MOD has been selected.
18. INT/EXT Counter Selector Select internal counter mode (count the frequency of model) or select EXT counter mode for an independent counter (input signal from BNC ㉑).

- | | | |
|-----|--------------------------------|--|
| 19. | EXT. Counter
Input Terminal | Accepts external signals for measurement. |
| 20. | TTL/CMOS
Output Terminal | TTL/CMOS compatible signal output |
| 21. | VCF/MOD
Input Terminal | Used to connect the input voltage required to perform the “voltage control frequency” operation or the EXT modulation operation. |
| 22. | Main Output
Terminal | Main signal output. |
| 23. | GCV Output | This is DC voltage output and its voltage amount will follow the change of Frequency. |
| 24. | Power Switch | 115V and 230V selectable. |

● **Remark:**

- (1)The functions of item 2, 2a, 3, 4, 5, 6, 14, 15, 16, 17, 19 and 23 can not be applied to model GFG -8215A.
- (2)The functions of item 14, 15, 16, 17 and 23 can not be applied to GFG -8216A, and GFG -8250A.
- (3)The function of item 15, 16-2, 16-3, 17 and 23 can not be applied to GFG -8217A.
- (4)The function of item 20 for GFG-8216A/8250A can be selected from front panel.
- (5)The function of item 20 and 21 for GFG-8215A can be selected from front panel.

5. USAGE DESCRIPTION

These function generators can provide versatile waveforms of high efficiency and convenient operation. Familiarize yourselves with these functions thoroughly through Operation Manual and practice with all accurate operation procedures can lead you to easily master the performance of these Function Generators.

It is one of the best ways to observe waveforms by connecting the instruments to Oscilloscope. Watch the effect in different control of waveforms through Oscilloscope carefully when proceeding the following steps:

5-1.First-step check:

- (1)Ensure that the voltage of the main supply is compatible with this instrument. The label on the rear panel states the required AC voltage.
- (2)Connect the instrument to the main supply using the power cord supplied.
- (3)Press PWR switch ① and ensure all the rotary controls are pushed in, then rotate AMPL ⑫ knob to make the indication point up forward.
- (4)Rotate the FREQ ⑬ control fully anticlockwise.

5-2. Triangle, square and sine wave

- (1) First select Function ⑧, and select Range ⑦, rotate FREQ ⑬, to set the required frequency.(read out from display window).
- (2) At this moment, connect Output ⑳, to oscilloscope for observing output signal, or connect to other experiment circuit.
- (3) Rotate AMPL ⑫ again to control waveform amplitude.
- (4) If attenuation output signal is required, pull out AMPL ⑫ knob to obtain 20dB attenuation or press (12a) knob for additional 20dB attenuation..
- (5) The phase-relation of Output Waveform shown in Figure 1 as below:

● Figure 1.

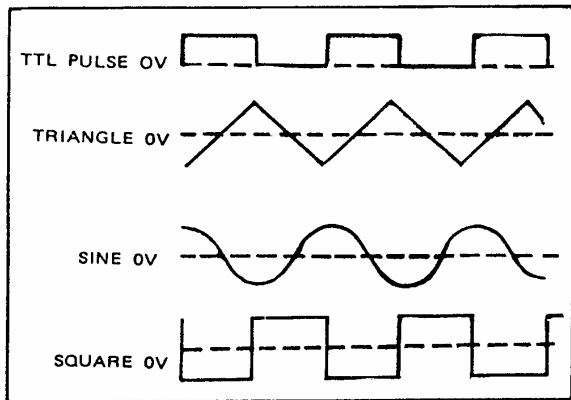

5-3. Pulse wave generation

- (1) First press the key (\square) of Function ⑧; then select Range ⑦, and rotate FREQ ⑬, to set required frequency range.
- (2) Connect output-terminal ㉒ to oscilloscope for observing output signal.
- (3) Pull out and rotate Duty ⑨ to adjust the width of pulse waveform.
- (4) Adjust AMPL ⑫ knob to control pulse amplitude.
- (5) Pull out AMPL ⑫ knob to get 20dB attenuation of output.

5-4. Ramp wave generation

- (1) First press the key (∇) of Function ⑧, then select Range ⑦, rotate FREQ ⑬ switch to set required frequency range.
- (2).Connect output-terminal ㉒ to oscilloscope for observing output signal.
- (3) Pull out and rotate DUTY ⑨ to adjust the slope of ramp waveform.
- (4).Adjust AMPL ⑫ knob to control output amplitude of ramp waveform.
- (5).Pull out AMPL ⑫ knob to obtain 20dB attenuation of output.

5-5. TTL/CMOS signal output

- (1) First select Range ⑦, rotate FREQ ⑬ to set required frequency range.
- (2) Connect BNC connector of TTL/CMOS ㉑ to oscilloscope or to other experiment circuit for observing output signal.
- (3) At this moment, output is square waveform fixing to TTL level; suits for general TTL integrated circuit.
- (4) If square waveform of CMOS level is required, can pull out CMOS ⑩ knob to adjust voltage level.

5-6. Variation of external voltage-controlled frequency

This mode of operation allows the user to adjust the frequency of the function generator with an external DC control Voltage. It also provides an easy way for your adjustment.

- (1) Select Function ⑧ first, then select Range ⑦, rotate FREQ ⑬ to set required frequency range.
- (2) Connect external control voltage ($0 \pm 0V$) to the VCF ⑳ connector via a suitable lead, and generate signal from Output ㉒.
- (3) Other adjustments, such as AMPL ⑫ switch can change amplitude of signal, or get attenuation; adjust Offset ⑪ for DC level, rotate Duty ⑨ switch can change output signal of pulse or ramp waveform etc..

5-7. Auto Sweep

- (1) First select the required waveform by pressing Function ⑧ button, then select required frequency range by pressing range ⑦ push button.
- (2) Connect output terminal ㉒ to oscilloscope for observing output signal.
- (3) Rotate frequency ⑬ to determine the upper limit frequency.
- (4) Pull out frequency ⑬ to perform auto-sweep operation.
- (5) Rotate SWEEP/TIME ⑭ and SWEEP/RATE ⑯ to adjust sweep time and rate.
- (6) Pull out (press) LIN/LOG ⑬ to obtain LOG (LIN) sweep mode.

Note: The sweep width can only be adjusted during the sweep cycle and it can not be stopped.

5-8. AM/FM operation

- (1) Select function ⑧ first; then select Range ⑦, rotate FREQ ⑬ to set required frequency range.
- (2) Connect output terminal ㉒ to oscilloscope for observing output signal.
- (3) Press MOD ⑮ and pull out (press) MOD ⑯ to obtain FM/AM modulation mode.
- (4) Adjust MOD ⑯ to achieve required modulation ratio.

5-9. Precaution item

- (1) Adjust DC OFFSET, will provide to change voltage of $\pm 0V$ (no load) or $\pm 5V$ (50 load). However, signal added DC level, is still limited to $\pm 20V$ (no load) or $\pm 10V$ (50 load). In case of over-voltage, clip will appear as shown in Figure 2:
- (2) Output connector label 50 , indicated that signal source impedance is 50 . Connect to any of impedance circuit, but output voltage and terminal impedance will be rated. To avoid oscillation, terminal shall be connected to 50 (When using high frequency and square output), and its connecting line shall be as short as possible.
- (3) When adjust Duty knob to leftward position, the ratio of positive state to negative state, expand to not less than 80:20. It can expand Square wave to Pulse wave, expand Triangle wave to Ramp wave and Sine wave to unsymmetrical Sine wave. As shown in Figure 3 is for adjustment of Duty control to obtain required waveform.

● **Figure 2.**

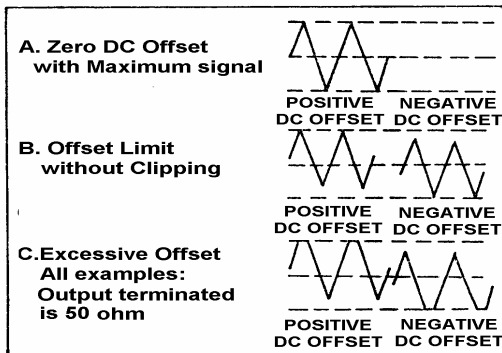

● **Figure 3.**

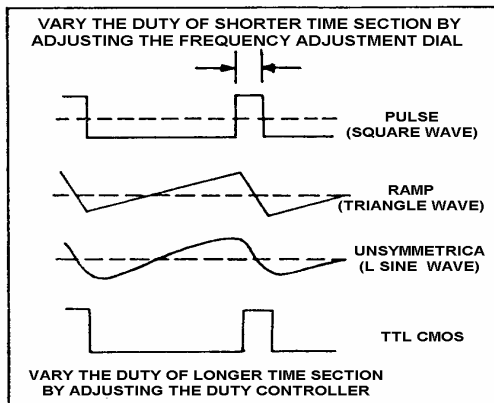

6. APPLICATION NOTE

This section describes the application of the Function Generators in details as well as a brief description relating to the block diagram. Only for the essential application method.

(A) Trouble-shooting using signal-tracing method.

This method is similar to signal replacing way. The signal of model will be fixedly sent to input terminal. Observing its signal wave on the oscilloscope from front stage to rear stage orderly until appear a signal with normal input but with abnormal output.

(B) Use as bias source and signal source circuit.

Utilize the Figure 4 of connecting type, which can provide bias of a transistor and signal input. The output waveform can be observed from oscilloscope. Adjust to the best condition with output max. amplitude and no distortion. Adjust DC OFFSET to see the different effect of different bias condition.

(C) Amplifier over-load characteristics

The Sine wave input will be different from output the overload point. Using Triangle wave will easily observe the display of oscilloscope. It can decide the linear range of output waveform. And the largest no-distortion output amplitude.

(D) Using the Square wave test the characteristics of amplifier circuit.

It can't actually explain the transient response of amplifier by using Sine wave for the frequency response curve observation, but using the high order poly-wave, Square wave, instead to display its waveform from the oscilloscope can show up many characteristics of amplifier.

- (a) Using the circuit of figure 5, the 50 connector trim the oscillation effect of Square wave.
- (b) Use the output of Triangle wave, adjust the amplitude until there are no clipping happened in the applied frequency.
- (c) Select Square wave, adjust frequency, choose to watch the wave-form of middle of amplifier pass band, like 20Hz, 1kHz, 10kHz and etc.
- (d) The output waveform of (c), must get something with frequency Figure 6 shows some possible conditions.



CAUTION: The composed poly-wave frequency of Square wave is quite large, so it's not suitable for the narrow band amplifier testing.

(E) Test of logic circuit

This equipment is suitable for logic circuit testing. Using Square or Pulse wave can analyze or watch the frequency waveform of a designed testing circuit. Also the DC Offset effect, drive the plug-in model board or logic circuit trouble-shooting and etc. Used as signal tracing and signal replacing operation:

- (a) Connect the lines as Figure 7.
- (b) According to the operation guide in this manual, set Square wave or Pulse wave output.
- (c) Use the label TTL, CMOS output terminal testing TTL logic circuit.
- (d) To test CMOS circuit by pulling up the switch of TTL/CMOS, and adjust CMOS level by rotating the switch to set the proper level
- (e) Use dual-trace scope to show the input-output timing relation judged by the two waves shown in Figure 4.

(F) Testing of speaking and impedance network

This equipment can be used to test the frequency characteristics of speaker or any impedance network. It also can get the resonant frequency of network.

- (a) Connect the device under test as in Figure 8, can use oscilloscope instead of voltmeter.
- (b) When use voltmeter, adjust the frequency of instrument record down voltage relative to frequency.
- (c) When testing speaker, if there is a peak volt value, when in low freq., this must be the resonant freq. of this speaker, see Figure 10. Whether installation may cause any effect to this frequency or not? The proper design of case-installation will cause two small ramps on both sides of this sharp ramp.
- (d) In testing other impedance network, the resonant may not occur in low frequency. But in approaching the resonant frequency, there are still increasing in voltage, then the impedance can be tested as

following:

- (1) Series connect a R1 to the network under test as in Figure 9.
- (2) Get voltage read out in E1, E2, adjust R1 until E2 is equal to one half of E1.
- (3) Under this frequency, the impedance network is the same as the R1.

(G)Act as automatic test of speaker

Because there provide the auto feature in this equipment, the output can drive to amplifier for testing the frequency response of speaker.

- (a)Set Auto/Manual to Auto position.
- (b)Set function to Sine wave
- (c)Set Range to 20kHz
- (d)Sweep mode (LIN, LOG), sweep width, sweep time can be set in any value.
- (e)The line connected is showed in Figure 11.

● **FIGURE 4**

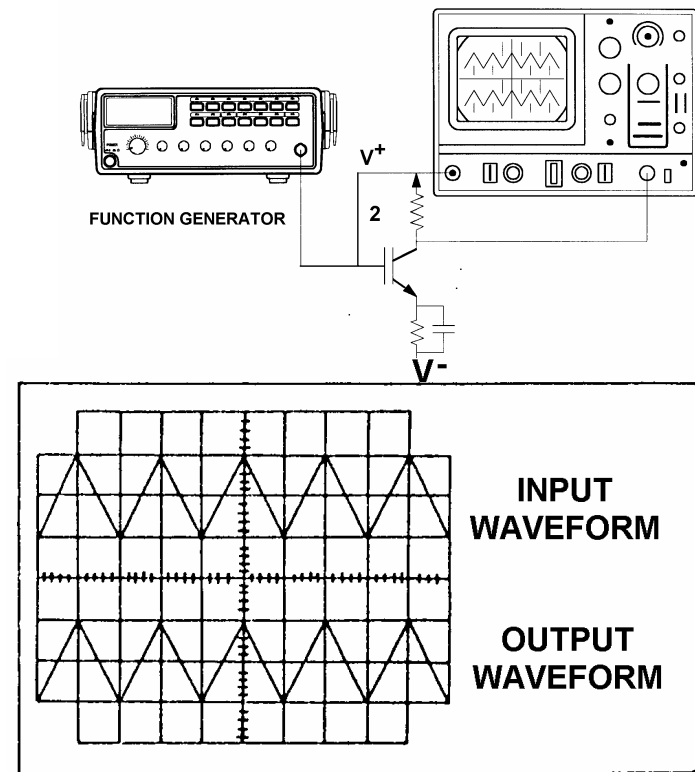

● **FIGURE 5**

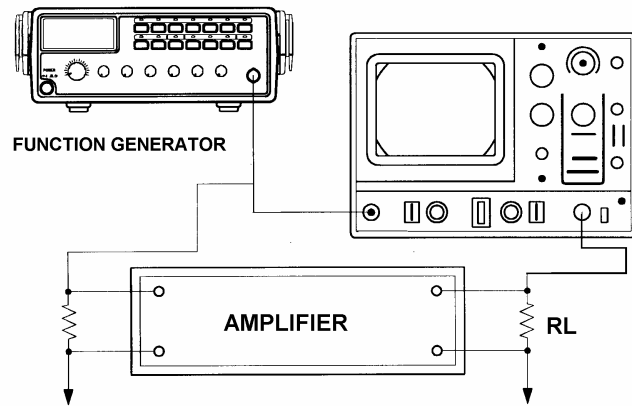

● **FIGURE 6**

Frequency distortion (amplitude reduction of low frequency). No phase shift	Low frequency boost (accentuated fundamental)	high frequency loss No phase shift	Low frequency phase shift (trace thickened by hum-voltage)	High frequency loss and phase shift
Low frequency phase shift	Low frequency loss and low frequency phase shift	High frequency loss and low frequency phase shift	Damped oscillation	Standard square wave

● FIGURE 7

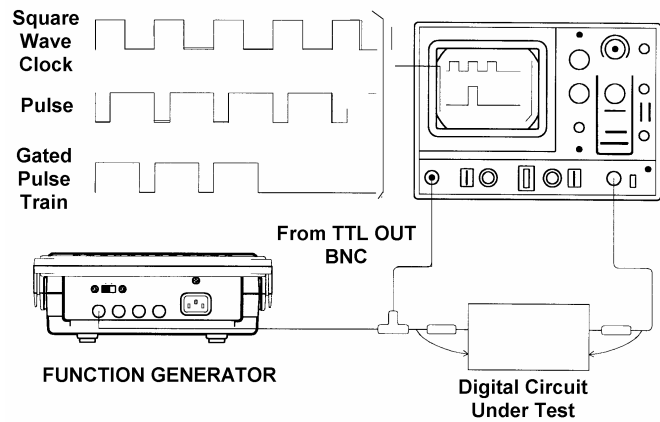

● FIGURE 8

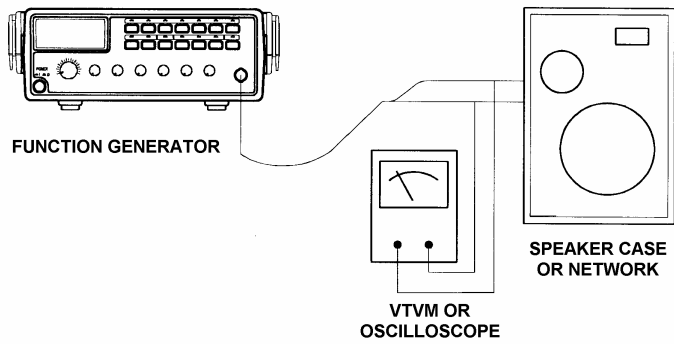

● FIGURE 9

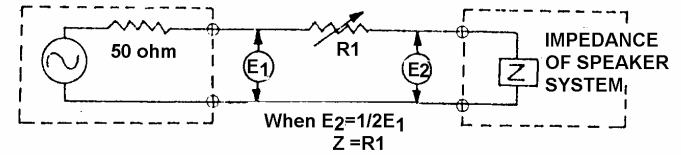

● FIGURE 10

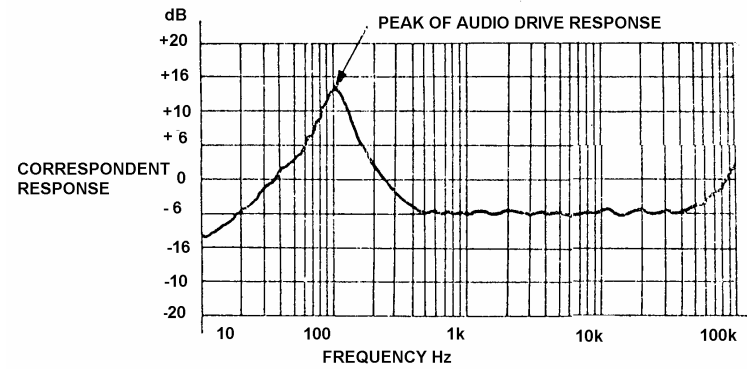

● **FIGURE 11**

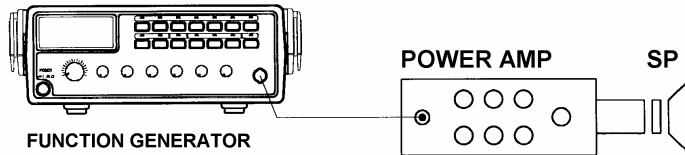

7. MAINTENANCE

The following instructions are used by qualified person only to avoid electrical shock, do not perform any service other than contained in the operation instructions unless you are qualified to do so.

7-1. Fuse Rating and type

If the fuse blows, the FUNCTION GENERATOR will not operate. Try to determine and correct the cause of the blown fuse, then replace the fuse with correct rating and type shown as below:

MODEL	FUSE Rating and Type		Rating Input	
	115V	230V	Watts	VA
GFG-8215A	T0.315A 250V	T0.16A 250V	22	28
GFG-8216A	T0.315A 250V	T0.16A 250V	25	32
GFG-8217A	T0.315A 250V	T0.16A 250V	27	34
GFG-8219A	T0.315A 250V	T0.16A 250V	29	36
GFG-8250A	T0.315A 250V	T0.16A 250V	25	32
GFG-8255A	T0.315A 250V	T0.16A 250V	29	36



WARNING: For continued fire protection, replace only with 250V fuse of the specified type and rating, and disconnect the power cord before proceeding fuse replacement.

7-2.Fuse Replacement Procedure

When you proceed calibration or maintenance of the Function Generators, if you want to replace the fuse, the upper cover must be removed according to the following steps:

- 1).The handle must be turned downward 90 degrees first.

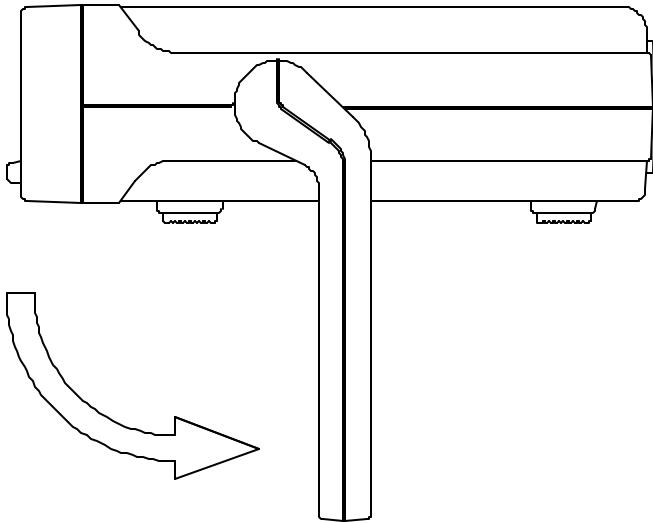

- 2).Pull apart the handle from the Function Generator. Please turn the handle left and right side slightly, that will make easier to pull off the handle.

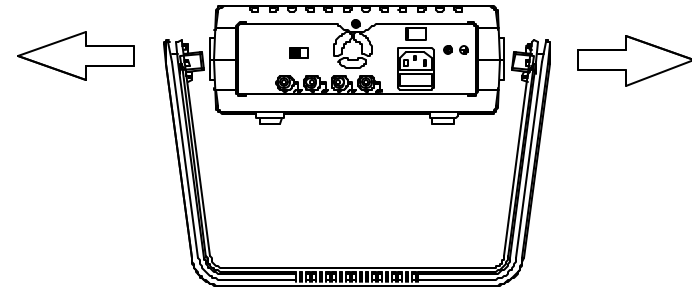

- 3).There are two washers inside of two holes (the joints of handle and case) respectively. Please use a screwdriver to pry open these washers.

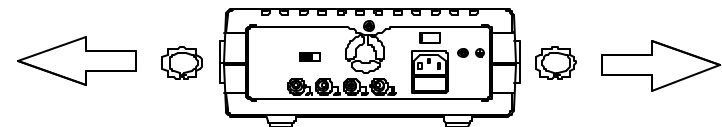

4).Please use a screwdriver to open the screw located at upper side of rear panel. Therefore, the upper cover can pull toward the backside. In the meantime, the upper cover is moved.

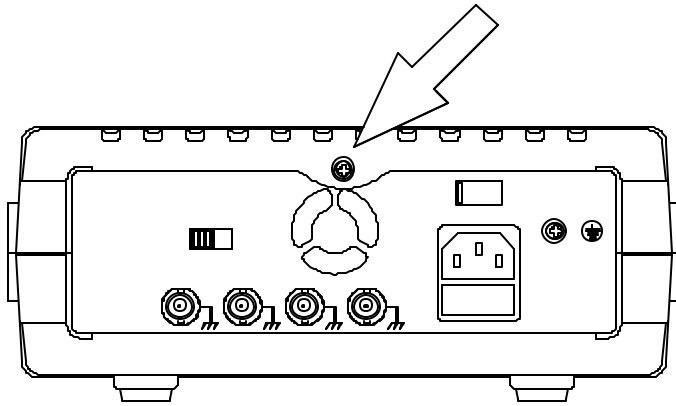

Note: If you want to install the upper cover, please reverse above steps.

7-3. Cleaning

To keep the instrument clean, wipe the case with a damp cloth and detergent. Do not use abrasives or solvents.