

Particle Physics - Chapter 4

Weak Interactions



Paolo Bagnaia

SAPIENZA
UNIVERSITÀ DI ROMA

AA 18-19

4 – Weak interactions

1. [The weak interactions](#)
2. [Charged currents](#)
3. [Lepton universality](#)
4. [Parity violation](#)
5. [The \$\nu\$ helicity](#)
6. [Weak decays](#)
7. [\[Decay \$\pi^0 \rightarrow \gamma\gamma\$ \]](#)
8. [\$\beta\$ decay](#)
9. [Quark decays](#)
10. [Summary](#)

[\[some basic math\]](#)

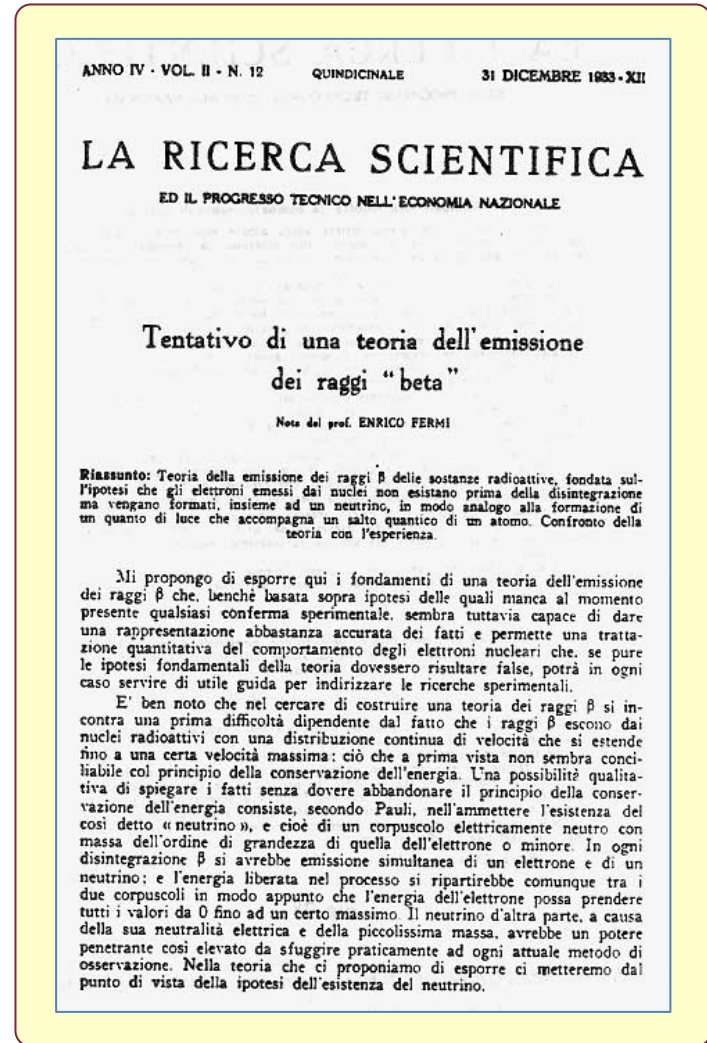

This chapter is just the preamble of our discussion on w.i.; also § K^0 and § ν are mainly dedicated to w.i., while § $\bar{p}p$, § LEP and § LHC contain a good fraction of w.i.

the weak interactions : the origins

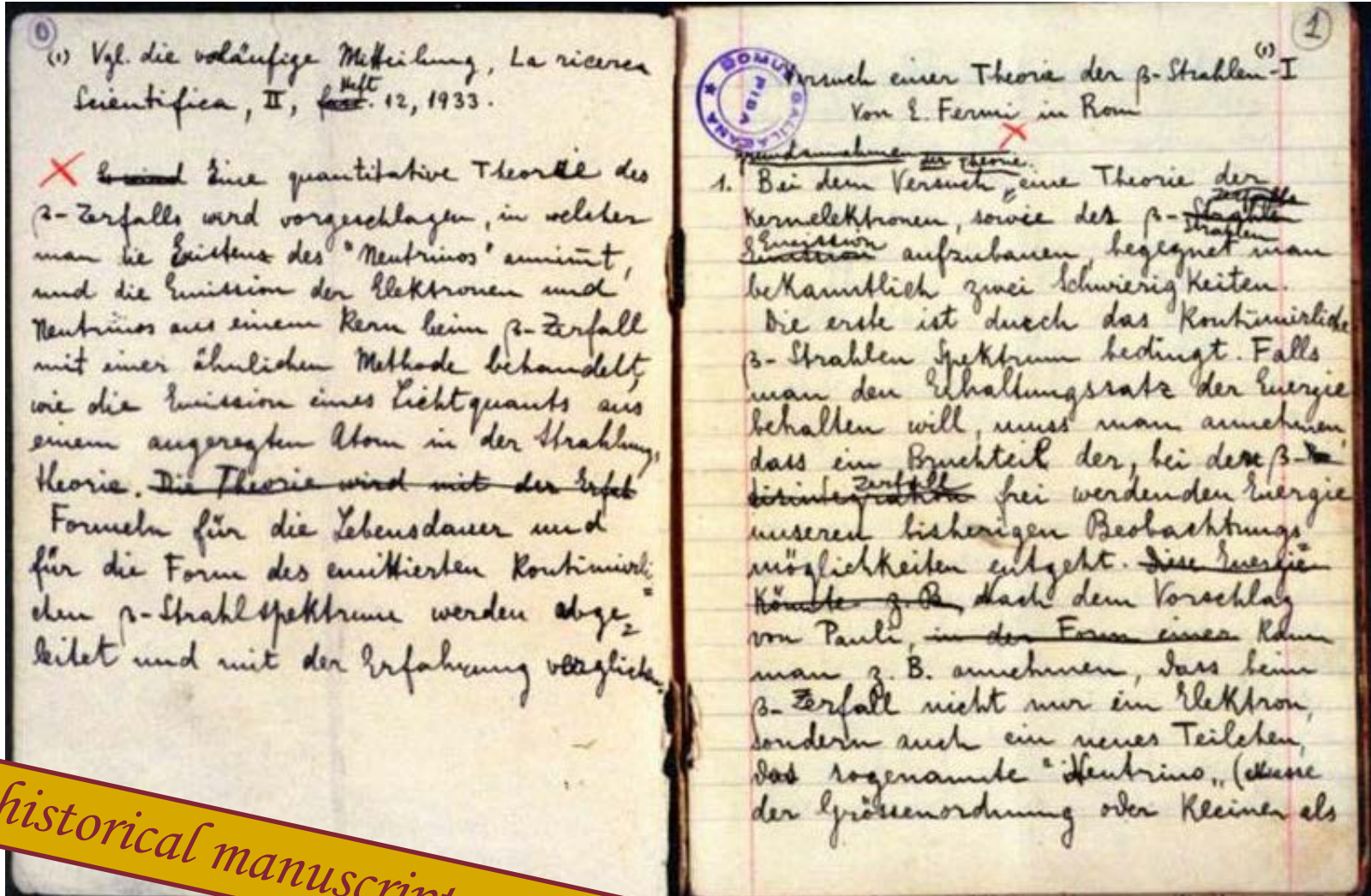

a historical manuscript [thanks to F. Guerra]



- Some rare processes, i.e. small coupling, violate the conservation laws, valid for strong and electromagnetic interactions.
- In ordinary matter the **weak interactions** (w.i.) have a negligible effect, except in cases otherwise forbidden (e.g. β decay).
- The w.i. are responsible for the fact that **STABLE** matter contains only u and d quarks and electrons. Other quarks and leptons are **UNSTABLE** because of w.i..
- Therefore, in spite of their "weakness" (small range of interaction $\approx 10^{-3}$ fm, tiny cross sections $\approx 10^{-47}$ m²), the w.i. play a crucial role in the features of our world.
- ALL elementary particles, but ~~gluons~~ and ~~photons~~ (carriers of other interactions), are affected by w.i. : quarks and charged leptons have w.i., ν 's have ONLY them.

- In the scattering processes of charged hadrons and leptons, the effects due to the strong and electromagnetic interactions "obscure" those of the w.i..
- Therefore most of our knowledge on this subject, at least until the '70s, has been obtained from the study of the decays of particles and from ν beams.

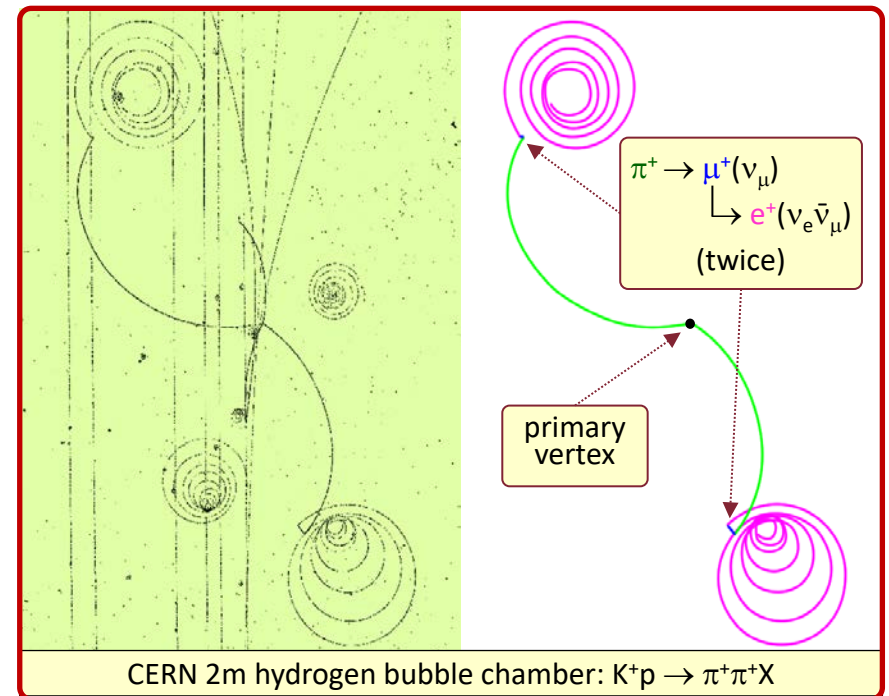



- 1930 Pauli : ν existence to explain β -decay.
 - 1933 Fermi : first theory of β -decay.
 - 1934 Bethe and Peierls : νN and $\bar{\nu} N$ cross sections.
 - 1936 Gamow and Teller : G.-T. transitions.
 - 1947 Powell + Occhialini : decay $\pi^+ \rightarrow \mu^+ \rightarrow e^+$.
 - 1956 Reines and Cowan : ν 's detection from a reactor.
 - 1956 Landè, Lederman and coll. : K_L^0 .
 - 1956 Lee and Yang : parity non-conservation.
 - 1957 Feynman and Gell-Mann, Marshak and Sudarshan : V-A theory.
 - 1958 Goldhaber, Grodzins and Sunyar : ν helicity.
 - 1960 (ca) Pontecorvo and Schwarz : ν beams.
 - 1961 Pais and Piccioni : $K_L \leftrightarrow K_S$ regeneration.
 - 1962 First ν beam from accelerator : Lederman, Schwarz, Steinberger : ν_μ .
 - 1963 Cabibbo theory.
 - 1964 Cronin and Fitch : CP violation in K^0 decay.
 - 1964 Brout, Englert, Higgs : Higgs mechanism.
 - 1968 Weinberg-Salam model.
 - 1968 Bjorken scaling, quark-parton model.
 - 1970 GIM mechanism.
 - 1972 Kobayashi, Maskawa : CKM matrix.
 - 1973-90 ν DIS experiments : Fermilab, CERN.
 - 1973 CERN Gargamelle : neutral currents.
 - 1983 CERN Sp \bar{p} S : W^\pm and Z.
 - 1987 CERN Sp \bar{p} S : B^0 mixing discovery.
 - 1989-95 CERN LEP : Z production + decay.
 - 1997-2000 CERN LEP : W^+W^- production.
 - 1998-2000 ν oscillations.
 - 1999-20xx B^0 mixing detailed studies.
 - 2012 CERN LHC : Higgs boson.
- only major facts ≥ 1930 considered;
 - this chapter;
 - other chapters of these lectures;
 - other lectures in our CdL.



In the SM, weak interactions (w.i.) are classified in two types, according to the charge of their carriers :

- Charged currents (CC), W^\pm exchange:

- in the CC processes, the charge of quark and leptons CHANGES by ± 1 ; at the same time there is a variation of their IDENTITY, including FLAVOR, according to the Cabibbo theory (today Cabibbo-Kobayashi-Maskawa)

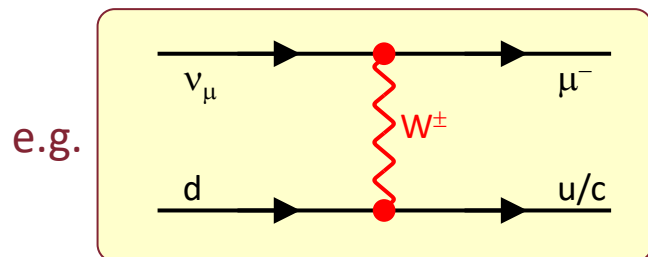

- Neutral currents (NC), Z exchange:

- in the NC case, quarks and leptons remain unchanged (no FCNC);
- until 1973 no NC weak process was

observed [but another example of NC was well known, i.e. the e.m. current: γ 's carry no charge !]

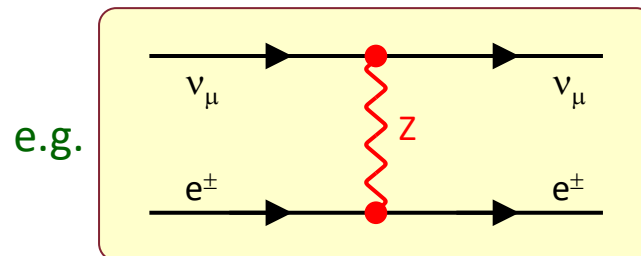

- In the 60's Glashow, Salam and Weinberg (+ many other theoreticians) developed a theory (today known as the "Standard Model", SM), that unifies the w.i. (both CC and NC) and the electromagnetism.

The SM was conceived BEFORE the discovery of NC. So the existence of NC and its carrier (the Z boson), predicted by the SM and observed at CERN in 1973 and 1983 respectively, were among the first great successes of the SM.





weak interactions	CC	leptonic	$\Delta S = 0$	$\mu \rightarrow e \nu_e \nu_\mu$	①	
		semi-leptonic		$\pi^\pm \rightarrow \mu^\pm \nu_\mu$	②	
				$n \rightarrow p e \nu_e$	①*	
				$\nu_e d \rightarrow e^- u$	③*	
				$d\bar{u} \rightarrow W^- \rightarrow e^- \bar{\nu}_e$	②*	
		hadronic		$\Delta S = \pm 1$	$K^\pm \rightarrow \mu^\pm \nu_\mu$	②
					$\Lambda \rightarrow p e \nu_e$	①*
					$K^\pm \rightarrow \pi^\pm \pi^0$	②*
	$\Lambda \rightarrow p \pi^-, n \pi^0$		①*			
	NC	leptonic	$\Delta S = 0$ (only)	$\nu_\mu e^\pm \rightarrow \nu_\mu e^\pm$	④	
semi-leptonic		$\nu N \rightarrow \nu N'$		④*		
hadronic		$u \bar{u} \rightarrow Z \rightarrow q \bar{q}$		⑤*		

Some processes (list NOT exhaustive), classified in terms of general characteristics and Feynman diagrams.

A "*" in the last column means that the interacting hadron is composite; the diagrams shows only the interacting quark(s); the other partons (the "spectators") do not participate in the interaction, at least in 1st approximation.

In the table, ν means both ν and $\bar{\nu}$ [only the correct one !].

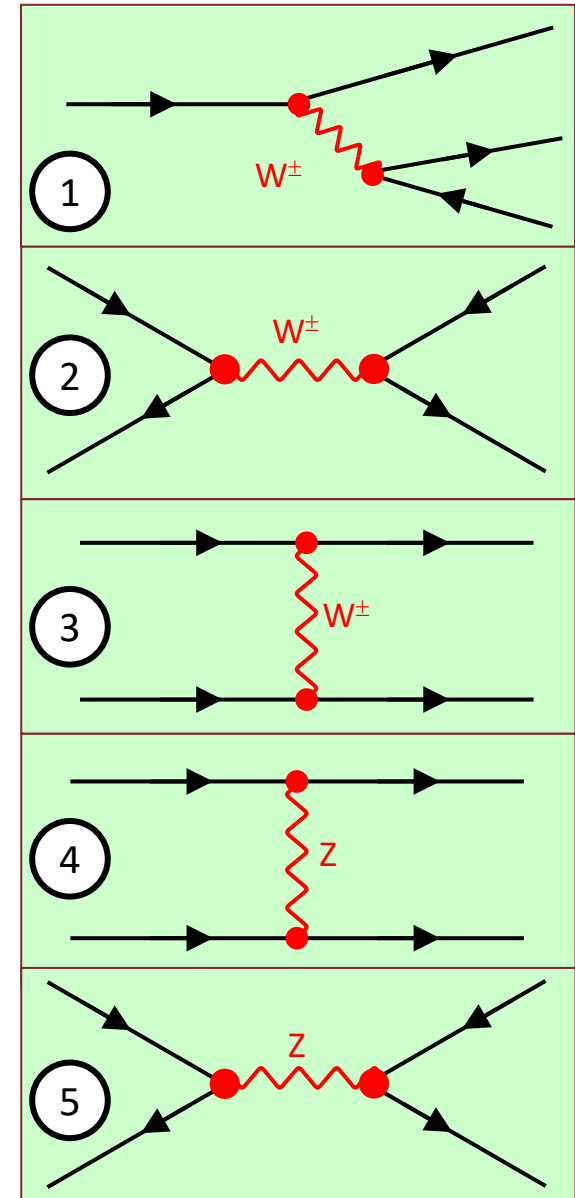

charged currents : decays

process	Lifetime (s)	comment
$\bar{\nu}_e p \rightarrow n e^+$	(none)	Neutrinos have only weak interactions (not a decay).
$n \rightarrow p e^- \bar{\nu}_e$	$\mathcal{O}(10^3)$	Long lifetime because of small mass difference (p-n).
$\pi^+ \rightarrow \mu^+ \nu_\mu$	$\mathcal{O}(10^{-8})$	The π^\pm is the lightest hadron, so it decays \rightarrow leptons.
$\Lambda \rightarrow p \pi^-$	$\mathcal{O}(10^{-10})$	The decay of Λ violates strangeness conservation.

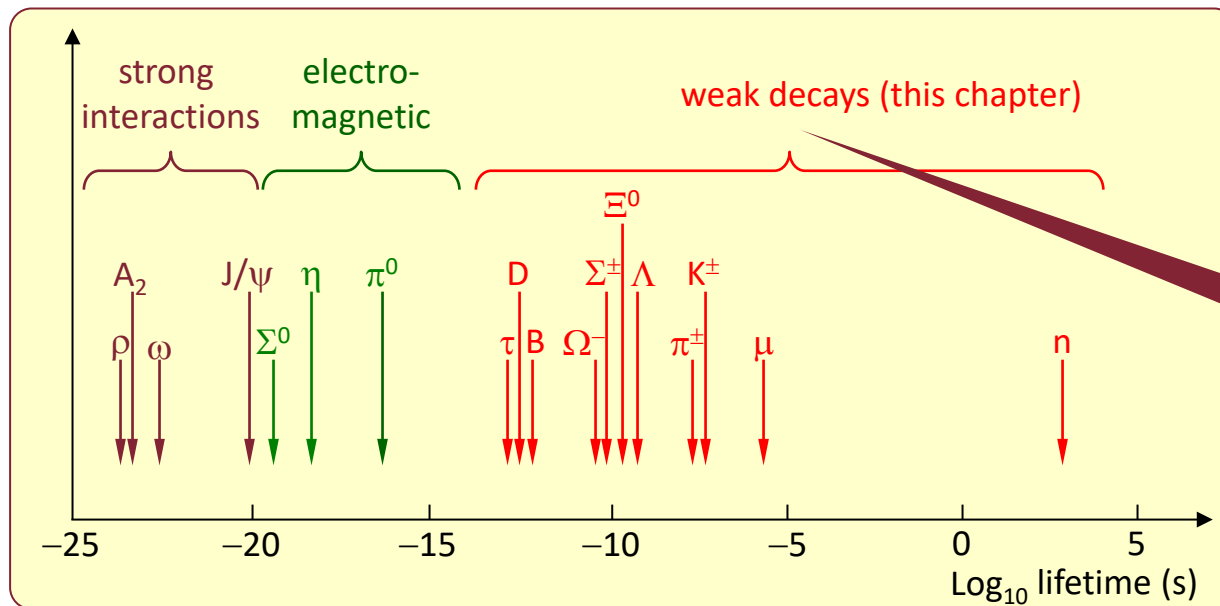

Some of the most interesting weak decays are the neutral heavy mesons of type $Q\bar{Q}$ (K^0 , B^0) [see § 5].



charged currents : Fermi theory

- The modern theory of the CC interactions (i.e. this part of the SM) is a successor of the Fermi theory of β decay.
- The Fermi theory describes a point-like interaction, proportional to the coupling G_F ; the theory had intrinsic problems ("not renormalizable" in modern terms, i.e. cross-sections violate unitarity at high energy);
- the SM "expands" the point-like interaction, introducing a heavy charged mediator, called W^\pm .
- the SM is mathematically consistent (it is "renormalizable");
- (more important) it reproduces the experimental data with unprecedented accuracy.

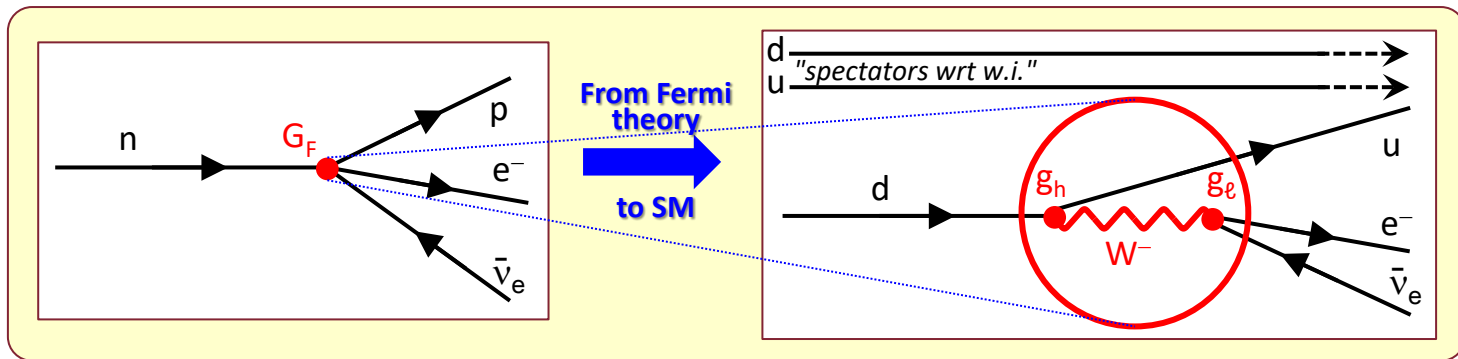

usual comment : to see a smaller scale requires higher $Q^2 \rightarrow$ higher energy





Q. why is the decay $n \rightarrow p\pi^-$ (similar to $\Delta^0 \rightarrow p\pi^-$) forbidden ?

A. write the Feynman diagram

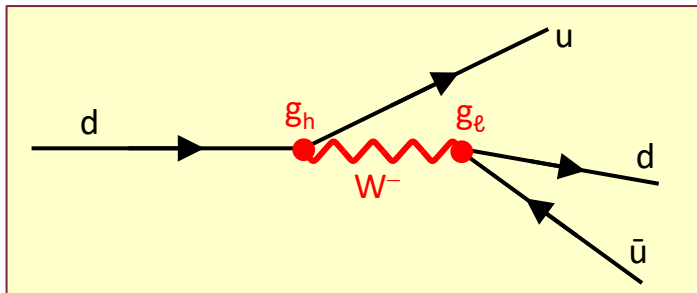

• possible ? forbidden ?

yes, possible

• then ?

$$m(n) - m(p) \approx 1.3 \text{ MeV}$$

The only possible pair ff' with $q = -1$ and baryon/lepton number = 0 is clearly $e^-\bar{\nu}_e$, since $m(e^-) + m(\bar{\nu}_e) \approx m(e^-) \approx 0.5 \text{ MeV}$.

Q. why $n \rightarrow pe^-\bar{\nu}_e$ and not $p \rightarrow ne^+\nu_e$?

A. [... left to the reader]



charged currents : coupling

A simple comparison between the couplings (g is the "charge" of the w.i. and plays a similar role as e):

- Electromagnetism :

$$\alpha \propto e^2;$$

$$\text{amplitude} \propto \alpha \propto e^2;$$

$$\text{rate} \propto \alpha^2 \propto e^4.$$

- Weak interactions :

$$G_F \propto g^2;$$

$$\text{amplitude} \propto G_F \propto g^2;$$

$$\text{rate} \propto G_F^2 \propto g^4;$$

NB. unlike α , G_F is not adimensional (next slide); the similarity electromagnetism \leftrightarrow weak interactions is hidden.

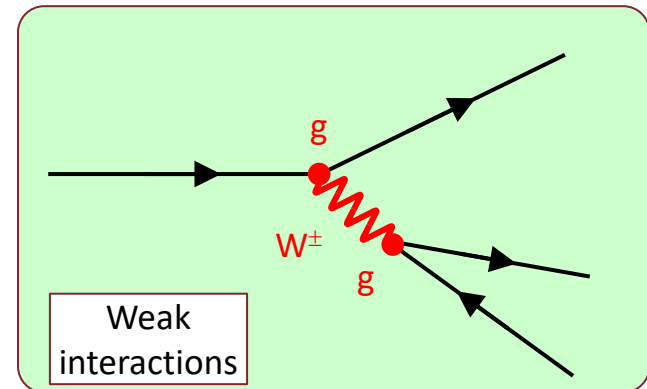
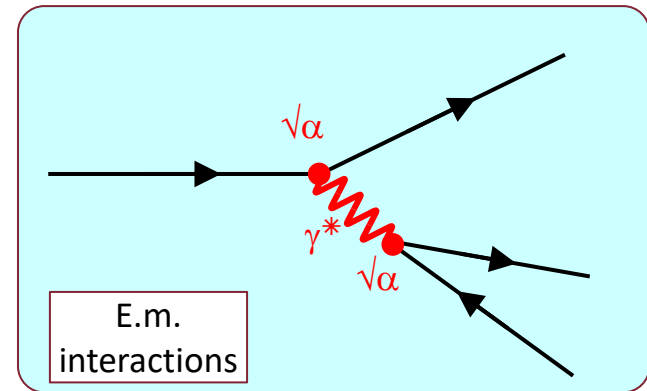

charged currents : effect of m_W on coupling

- The e.m. coupling constant α is proportional to the square of the electric charge e :

$$\alpha = \frac{e^2}{4\pi\epsilon_0\hbar c} \approx \frac{1}{137}.$$

- In a similar way, the intensity of the CC is G_F (Fermi constant), proportional to the square of the "weak charge" g .
- The matrix elements of the transitions are proportional to the square of the "weak charge" g and to the propagator :

$$\mathcal{M}_{fi} \propto g \frac{1}{Q^2 + m_W^2} g \xrightarrow{Q^2 \ll m_W^2} \frac{g^2}{m_W^2} \equiv G_F.$$

- The difference respect to the e.m. case is the mass of the carrier: while the γ is massless, the CC carrier is the W^\pm , a massive particle of spin 1. Therefore the range of CC turns out to be small ($1/m_W$).

- Unlike the case of the massless photon, for small Q^2 the propagator term "stays constant".

- Therefore the Fermi constant G_F has dimensions :

$$[G_F] = [m_W^{-2}] = [m^{-2}] = [\ell^2],$$

- and a small value, due to m_W :

$$\frac{G_F}{(\hbar c)^3} = O(10^{-5} \text{ GeV}^{-2}) = O[(10^{-3} \text{ fm})^2].$$

- This effect obscures the similarity of the e.m. and weak charges ($e \leftrightarrow g$), which are indeed of the same order [see § 6].

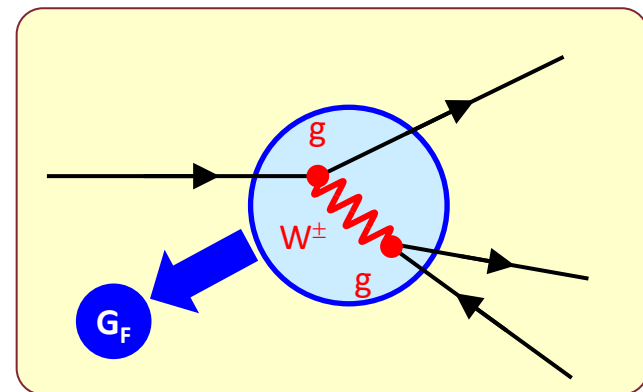

charged currents : G_F

- the most precise value of the Fermi constant G_F is measured by considering the muon decay $\mu^- \rightarrow \nu_\mu e^- \bar{\nu}_e$:
 - low energy process ($\sqrt{Q^2} \approx m_\mu \ll m_W$);
 - approximated by a four-fermion point-like process, determined by the Fermi constant ($\approx g^2/m_W^2$);
 - only leptons \rightarrow free from hadronic interactions which affect other processes, e.g. the nuclear β decays.
- if $m_e \approx 0$, m_μ is the only scale of the decay \rightarrow dimensional analysis:

$$\Gamma(\mu^- \rightarrow e^- \bar{\nu}_e \nu_\mu) = 1/\tau_\mu \propto G_F^2 m_\mu^5,$$

- while the correct computation gives :

$$\Gamma(\mu^- \rightarrow e^- \bar{\nu}_e \nu_\mu) = \frac{G_F^2 m_\mu^5}{192\pi^3} (1 + \varepsilon),$$

where ε is small and depends on the radiative corrections and on the electron mass.

- the mass of the muon and its average lifetime were measured with great precision:

$$m_\mu = (105.658389 \pm 0.000034) \text{ MeV};$$

$$\tau_\mu = (2.197035 \pm 0.000040) \times 10^{-6} \text{ s}.$$

- then the value of the Fermi constant is

$$G_F = (1.16637 \pm 0.00001) \times 10^{-5} \text{ GeV}^{-2}.$$

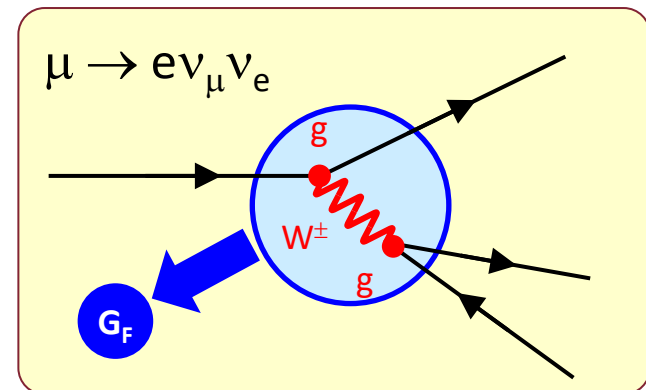

lepton universality : $(\tau \rightarrow e) \leftrightarrow (\tau \rightarrow \mu)$

Q. Is the weak CC the same for all leptons and quarks ? Do they share the same coupling constant G_F for all the processes ?

- the **CC universality** has received extensive tests.
- [absolutely true for leptons, some further refinement – **CKM** – for quarks]
- The **e- μ universality** is measured by analyzing the leptonic decays of the τ^\pm (ℓ^- is the appropriate lepton, e^- / μ^-) :

$$\Gamma(\tau^- \rightarrow \ell^- \bar{\nu}_\ell \nu_\tau) \equiv \Gamma_\ell^\tau = \frac{g_\tau^2 g_\ell^2}{m_W^2 m_W^2} m_\tau^5 \rho_\ell;$$

[where ρ_ℓ is the phase space factor]

$$\text{BR}(\tau^- \rightarrow \ell^- \bar{\nu}_\ell \nu_\tau) \equiv \text{BR}_\ell^\tau = \frac{\Gamma_\ell^\tau}{\Gamma_{\text{tot}}^\tau};$$

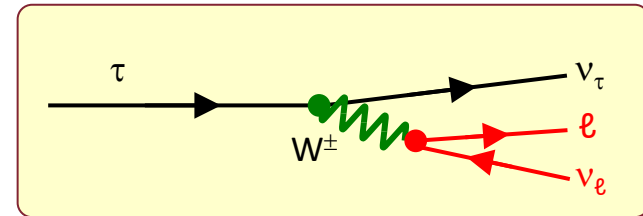

- it follows that :

$$\frac{\Gamma_\mu^\tau}{\Gamma_e^\tau} = \frac{\text{BR}_\mu^\tau}{\text{BR}_e^\tau} = \frac{g_\mu^2 \rho_\mu}{g_e^2 \rho_e} \rightarrow$$

$$\left. \frac{\text{BR}_\mu^\tau}{\text{BR}_e^\tau} \right|_{\text{meas.}} = \frac{(17.36 \pm .05)\%}{(17.84 \pm .05)\%} = 0.974 \pm .004,$$

and, taking into account the values of ρ_μ and ρ_e :

$$\left. \frac{g_\mu}{g_e} \right|_{\text{meas.}} = 1.001 \pm .002. \quad !!!$$



lepton universality : $(\mu \rightarrow e) \leftrightarrow (\tau \rightarrow e)$

The measurement of the μ - τ universality is similar [$\text{BR}_x = \Gamma_x / \Gamma_{\text{tot}} = \tau \Gamma_x$]:

$$\text{BR}(\mu^- \rightarrow e^- \bar{\nu}_e \nu_\mu) \approx 100\% \text{ (experimentally);}$$

$$\frac{\Gamma(\mu^- \rightarrow e^- \bar{\nu}_e \nu_\mu)}{\Gamma(\tau^- \rightarrow e^- \bar{\nu}_e \nu_\tau)} = \frac{\tau_\tau \text{BR}(\mu^- \rightarrow e^- \bar{\nu}_e \nu_\mu)}{\tau_\mu \text{BR}(\tau^- \rightarrow e^- \bar{\nu}_e \nu_\tau)},$$

the prediction is :

$$\frac{\Gamma(\mu^- \rightarrow e^- \bar{\nu}_e \nu_\mu)}{\Gamma(\tau^- \rightarrow e^- \bar{\nu}_e \nu_\tau)} = \frac{g_e^2 g_\mu^2 m_\mu^5 \rho_\mu}{g_e^2 g_\tau^2 m_\tau^5 \rho_\tau} = \frac{g_\mu^2 m_\mu^5 \rho_\mu}{g_\tau^2 m_\tau^5 \rho_\tau},$$

$$\rightarrow \frac{g_\mu^2}{g_\tau^2} = \frac{\tau_\tau}{\tau_\mu} \frac{1}{\text{BR}(\tau^- \rightarrow e^- \bar{\nu}_e \nu_\tau)} \frac{m_\tau^5 \rho_\tau}{m_\mu^5 \rho_\mu},$$

• from the measured values of m_μ , m_τ , τ_μ , τ_τ .

and $\text{BR}(\tau^- \rightarrow e^- \bar{\nu}_e \nu_\tau)$, we finally get :

$$\frac{g_\mu}{g_\tau} \Big|_{\text{meas.}} = 1.001 \pm .003.$$

!!!

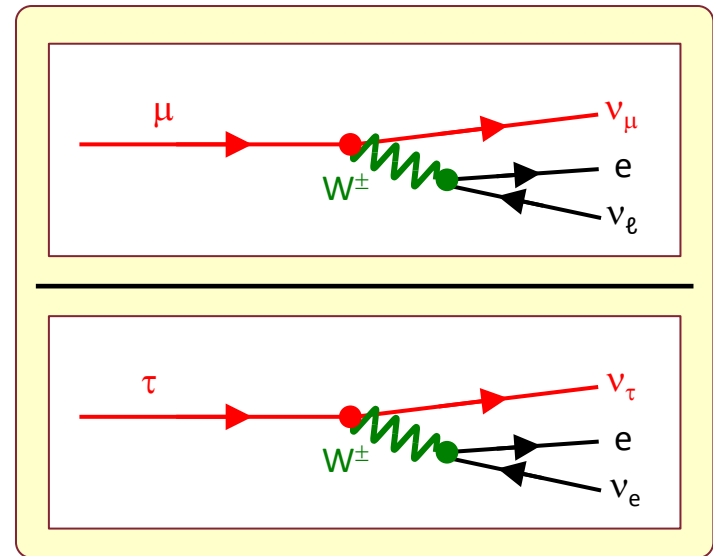

•

•

" τ_τ "?

lepton universality : τ decays

More ambitious test: extend universality to τ hadronic decays :

- consider again the leptonic decays of the τ lepton: mainly the following three decay modes :

$$\tau^- \rightarrow e^- \bar{\nu}_e \nu_\tau; \quad \tau^- \rightarrow \mu^- \bar{\nu}_\mu \nu_\tau; \quad \tau^- \rightarrow \bar{u} d \nu_\tau.$$

- from the BR_i ratio, expect (3 for color) :

$$\Gamma_{\tau \rightarrow e}^{\text{meas.}} \approx \Gamma_{\tau \rightarrow \mu}^{\text{meas.}} \approx \Gamma_{\tau \rightarrow \bar{u}d}^{\text{meas.}} / 3,$$

in excellent agreement with universality and presence of color in the hadronic sector [it is the first time we see the color appear in the weak interactions sector].

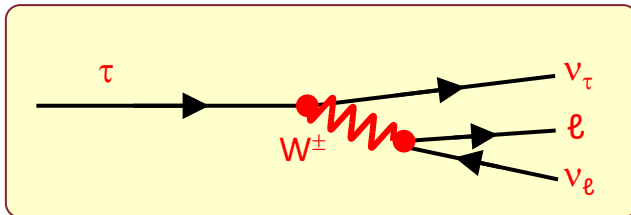

Another test is the τ lifetime :

$$\Gamma_{\tau \rightarrow \mu} \approx \frac{\Gamma_{\tau}^{\text{tot}}}{5} = \frac{m_{\tau}^5}{m_{\mu}^5} \Gamma_{\mu \rightarrow e} = \frac{m_{\tau}^5}{m_{\mu}^5} \frac{1}{\tau_{\mu}};$$

$$\tau_{\tau} = 1/\Gamma_{\tau}^{\text{tot}} \approx \frac{\tau_{\mu} m_{\mu}^5}{5m_{\tau}^5} \approx \boxed{3.1 \times 10^{-13} \text{ s}}; \quad !$$

experimentally it is found :

$$\tau_{\tau}^{\text{exp}} = \boxed{(2.956 \pm .031) \times 10^{-13} \text{ s}}. \quad !$$

- Many other experimental tests [... but I suppose that you are convinced].
- At least for CC weak interactions (but also in e.m., and in NC, as in the Z decay) all three leptons have exactly the same interactions.
- The only differences are due to their different mass.
- Isidor Isaac Rabi said in the 30's about the muon: "who ordered that ?".



lepton universality : Z decays

- A similar test on lepton universality has been performed at LEP, in the decay of the Z (a NC process).
- The experiments [see § LEP] have measured the decay of the Z into fermion-antifermion pairs.
- They [well, WE] have found :

$$Z \rightarrow e^+e^- : \mu^+\mu^- : \tau^+\tau^-$$

$$1. : 1.000 \pm .004 : .999 \pm .005.$$
- Similar – more qualitative – tests can be carried with angular distributions, higher orders, ... [see § LEP].
- The total amount of information is impressive and essentially no margin is left to any alternative theory.

warning – in these pages we mix measurements of different ages, e.g. μ -decay in the '50s, τ -decay in the '80s, Z-decay in the '90s.

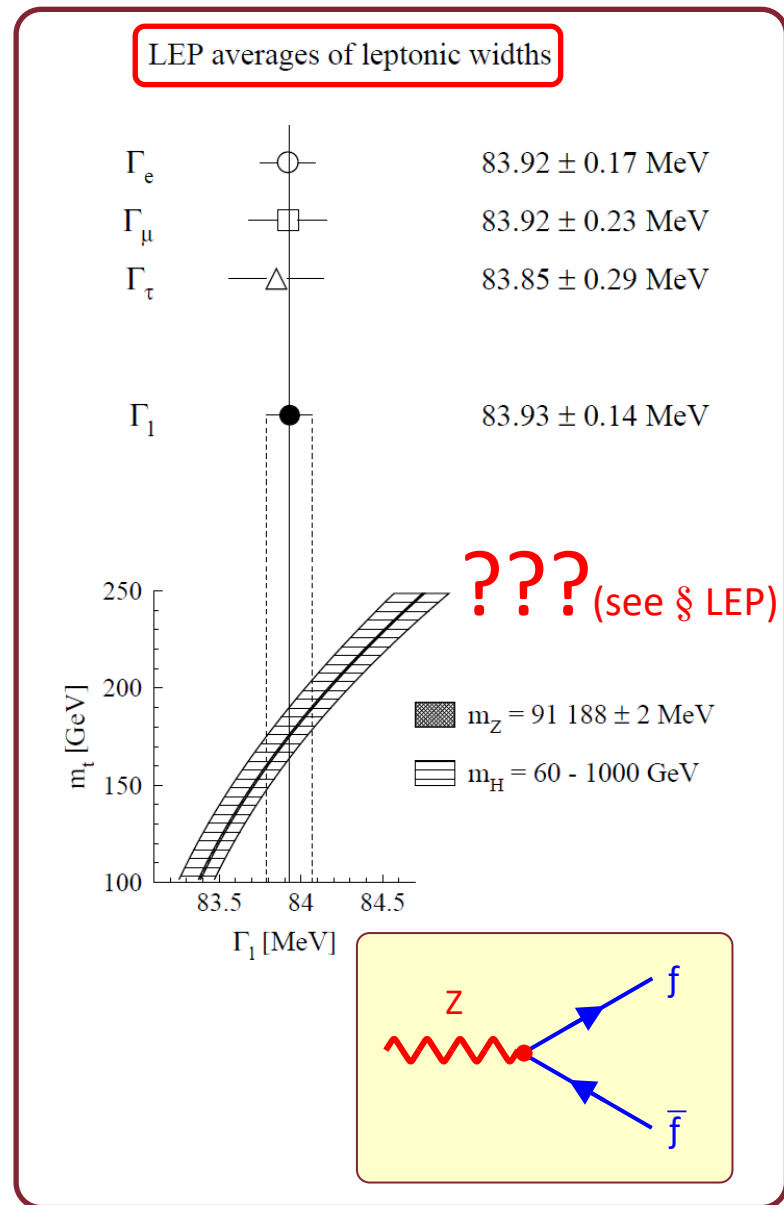

parity violation : history

- The effect was proposed in 1956 by two young theoreticians in a classical paper and immediately verified in a famous experiment (Mme Wu) [*FNSN 1*] and in the π^\pm - and μ^\pm -decays by Lederman and coll.
- The historical reason was a review of weak interaction processes and the explanation of the " θ - τ puzzle", i.e. the K^0 decay into 2π or 3π systems.

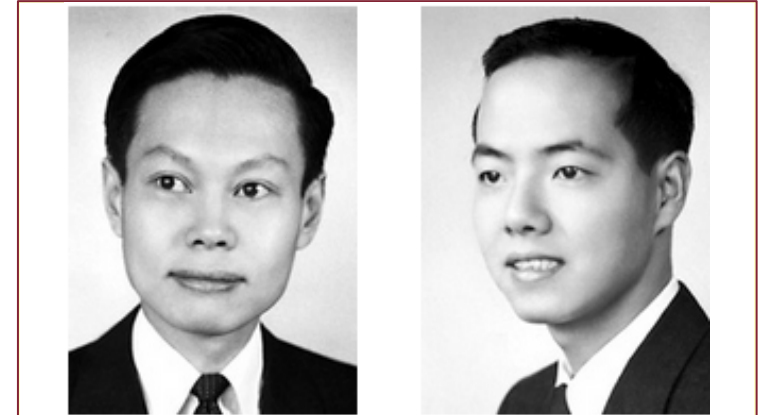
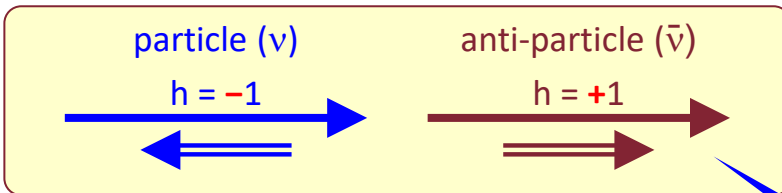

Nobel Prize 1957

Tsung-Dao Lee (Lǐ Zhèngdào, 李政道)

Chen-Ning Franklin Yang (Yáng Zhènníng,
杨振宁 or 楊振寧)

for their penetrating investigation of the so-called parity laws which has led to important discoveries regarding the elementary particles.

→
vectors & co.

- ν only $h=-1$;
 - $\bar{\nu}$ only $h=+1$;
- **PARITY VIOLATION**



parity violation : mechanism

- The two authors found that parity conservation in weak decays was NOT really supported by measurements.

[then experiment, and then a new theory]

- The CC current is "V - A", which is an acronym for the factor $\gamma_\mu(1 - \gamma_5)$ in the current; it shows that the CC have a "preference" for left-handed particles and right-handed anti-particles.

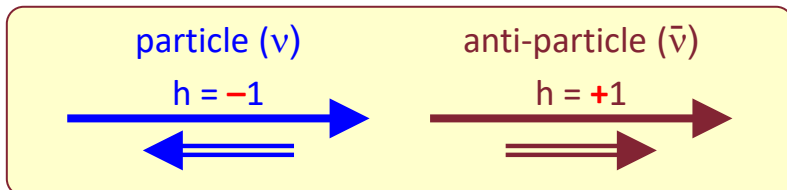

- These effects clearly violates the parity : the parity operator \mathbb{P} flips the helicity:

$$\mathbb{P} |v, h = -1 \rangle = |v, h = +1 \rangle$$

→ it changes ν 's with a -ve helicity into ν 's with +ve helicity, which DO NOT EXIST (or do not interact).

- Few comments :
 - V or A alone would NOT violate the parity. The violation is produced by the simultaneous presence of the two, technically by their interference.
 - The conservation is restored, applying also \mathbb{C} , the charge conjugation:

$$\mathbb{C}\mathbb{P} |v, h=-1\rangle = \mathbb{C} |v, h=+1\rangle = |\bar{\nu}, h=+1\rangle,$$

i.e. $\nu_{h=-1} \rightarrow \bar{\nu}_{h=+1}$, which does exist. Therefore, " $\mathbb{C}\mathbb{P}$ is not violated" [not by ν 's in these experiments, at least].

➤ *the above discussion holds only if $m_\nu = 0$ (NOT TRUE), or $m_\nu \ll E_\nu$ (ultra-relativistic approximation - u.r.a.); the u.r.a. for ν 's is used in this chapter.*



parity violation : the ν helicity

- For massless ν 's or in the u.r.a. approximation^(*), V–A implies :

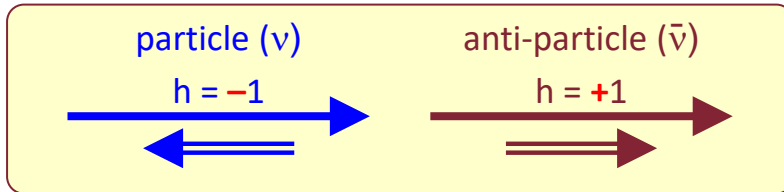

- Therefore in the "forbidden" amplitudes, there is a factor [$\propto (1 - \beta)$] for massive particles, which vanishes when $\beta \rightarrow 1$.
- If we assume a factor $(1 \pm \beta)$ for the production of ($h = \mp 1$) particles (the opposite for anti-particles), we get :

$$\langle h \rangle_{\text{part}} = \frac{1}{2} [(1 + \beta)(-1) + (1 - \beta)(+1)] = -\beta;$$

$$\langle h \rangle_{\overline{\text{part}}} = \frac{1}{2} [(1 + \beta)(+1) + (1 - \beta)(-1)] = +\beta;$$

i.e., when produced in CC interactions, particles in average have –ve helicity, while anti-particles have +ve helicity.

- The effect is maximal for ν 's ($\beta_\nu \approx 1$), which also have no other interactions.
- For e^- , it is also well confirmed by data in β decays [YN1, 570] :

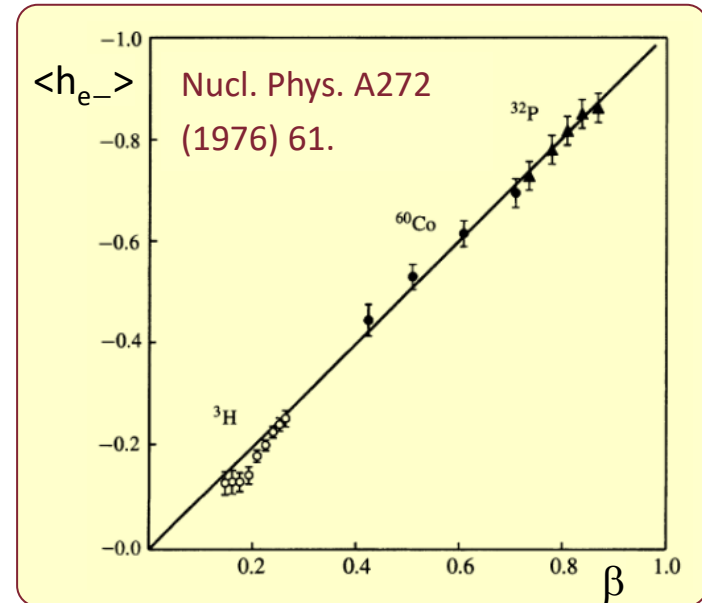

() If $m_\nu > 0 \rightarrow \beta_\nu < 1$; a L-transformation can reverse the sign of the momentum, and hence the ν helicity, so the following argument is NOT L-invariant for massive particles [previous slide].*





[... /] imagine that we were talking to a Martian, or someone very far away, by telephone. We are not allowed to send him any actual samples to inspect; for instance, if we could send light, we could send him right-hand circularly polarized light. [...] But we cannot give him anything, we can only talk to him.

[Feynman explains how to communicate: math, classical physics, chemistry, biology are simple]

[...] "Now put the heart on the left side." He says, "Duhhh - the left side?" [...] We can tell a Martian where to put the heart: we say, "Listen, build yourself a magnet, and put the coils in, and put the current on, and [...] then the direction in which the current goes through the coils is the direction that goes in on what we call the right.

[... However,] does the right-handed matter behave the same way as the right-handed antimatter? Or does the right-handed matter behave the same as the left-handed antimatter? Beta-decay experiments, using

positron decay instead of electron decay, indicate that this is the interconnection: matter to the "right" works the same way as antimatter to the "left."

[... We then] make a new rule, which says that matter to the right is symmetrical with antimatter to the left.

So if our Martian is made of antimatter and we give him instructions to make this "right" handed model like us, it will, of course, come out the other way around. What would happen when, after much conversation back and forth, we each have taught the other to make spaceships and we meet halfway in empty space? [...] Well, if he puts out his left hand, watch out!

From Feynman Lectures on Physics, 1, 52: "Symmetry in Physical Laws".



Quite amusing and great physics :

- the symmetry he is talking about is " $\mathbb{C}\mathbb{P}$ " and NOT simply " \mathbb{P} " or " \mathbb{C} " !!!
- but $\mathbb{C}\mathbb{P}$ is also violated [see § K⁰].



the ν_e helicity

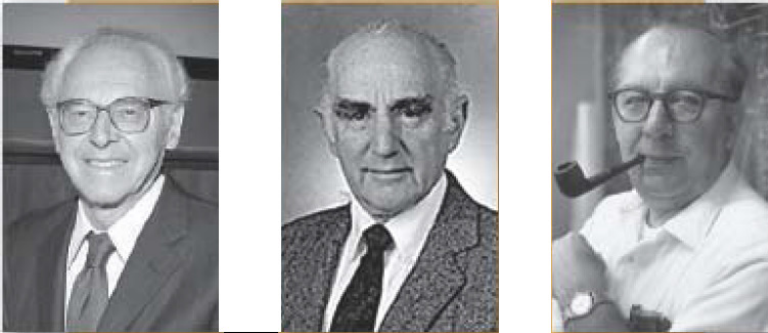

In 1958, Goldhaber, Grodzins and Sunyar measured the helicity of the electron neutrino ν_e with an ingenious experiment.

- A crucial confirmation of the V-A theory; pure V or A had been ruled out, but V+A was still in agreement with data.
- Metastable Europium (Eu) decays via K-capture \rightarrow excited Samarium (Sm^*) + ν_e , whose helicity is the result of the exp.;
- the Sm^* decays again into more stable Samarium (Sm), emitting a γ [γ_1 in fig.].
- For such a γ the transmission in matter depends on the e^- spins; therefore a large B-field is applied to polarize the iron.

- The γ 's are used to excite again another Sm; only γ 's from the previous chain may do it; another γ is produced [γ_2 in fig.].
- The resultant γ 's are detected.

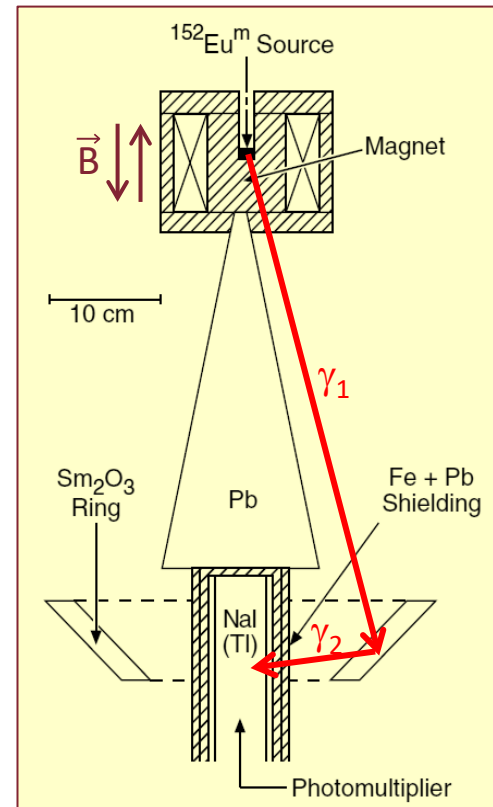

- Final result :

$$h(\nu_e) = -1.0 \pm 0.3$$
 consistent with V-A only.

[the experiment is ingenious and complex: it is discussed step by step.]



the ν_e helicity : summary of the experiment

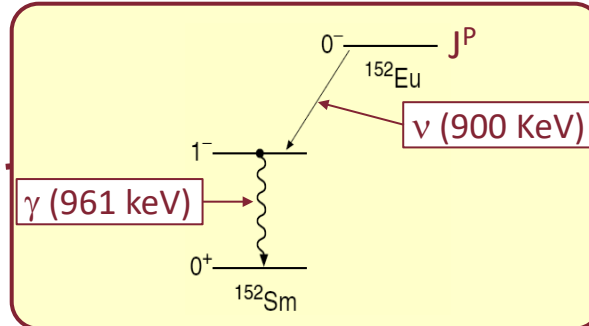
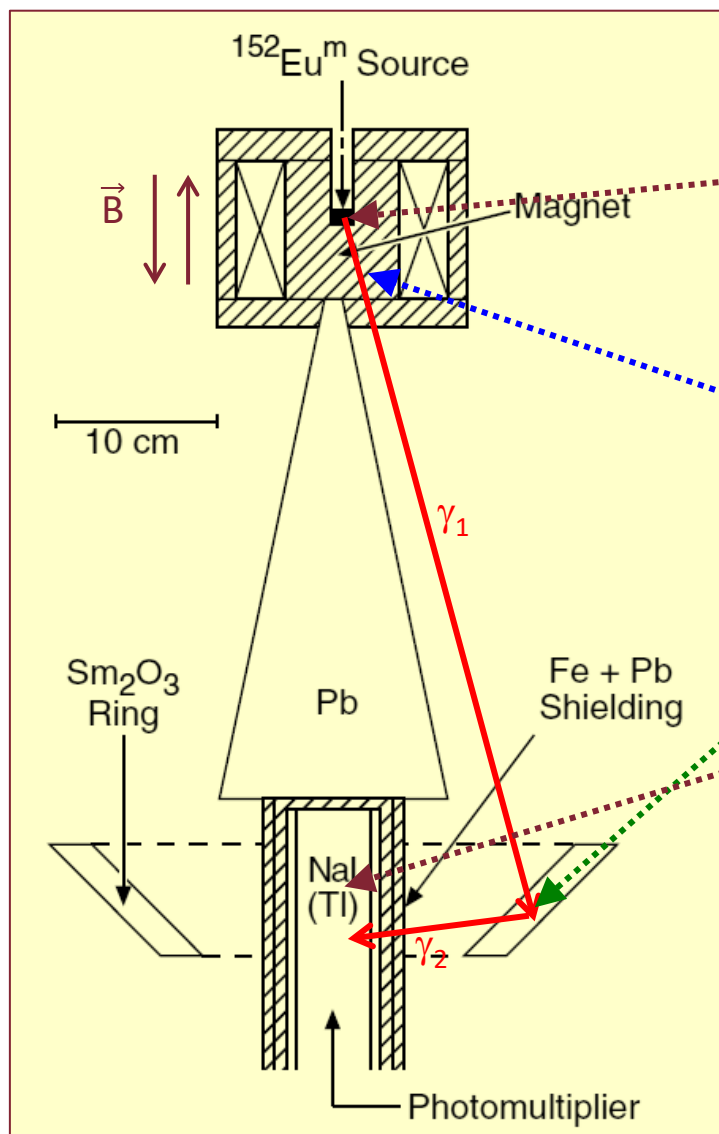

Compton effect does depend on the γ_1 -spin wrt \vec{B} (NB γ_1 in the figure escapes Compton effect).

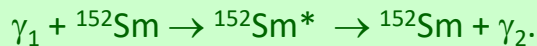

γ_2 detection via photomultiplier.

The experiment detects the number of γ_2 when \vec{B} is (anti-)parallel to γ_1 . The asymmetry depends on the (ν_e -helicity \rightarrow) γ_1 -spin.



the ν_e helicity : Europium \rightarrow Samarium $\rightarrow \gamma$

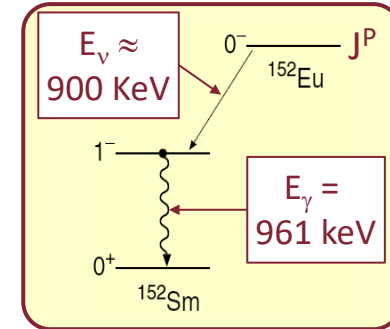
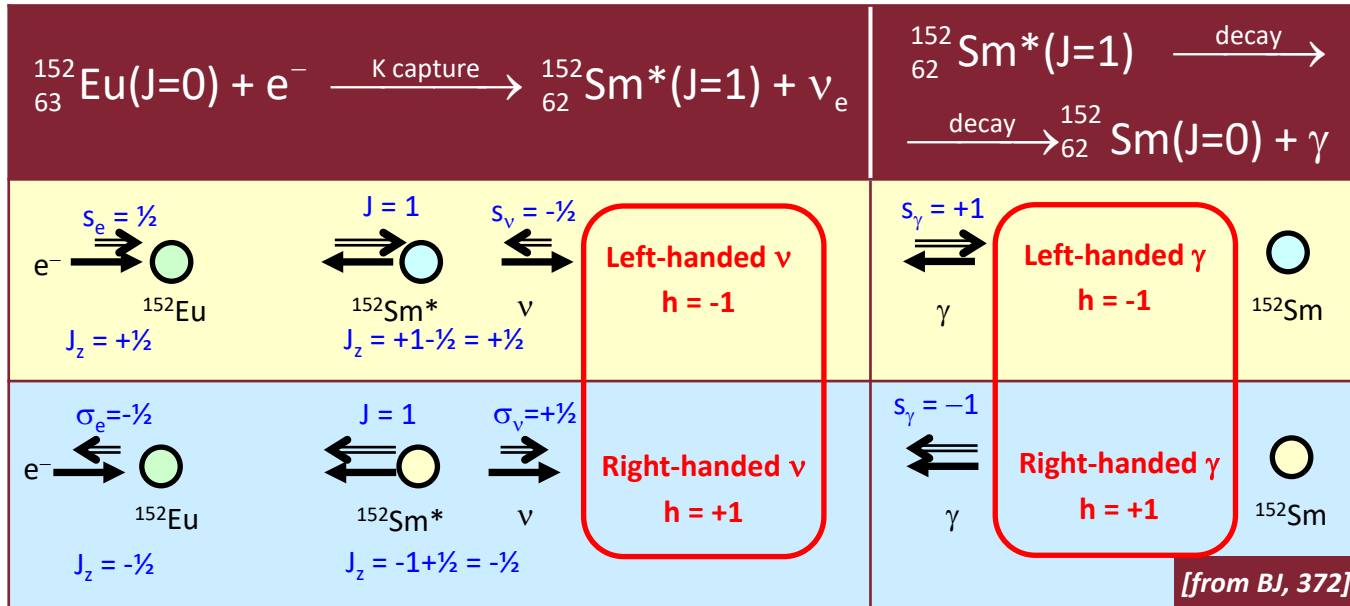

- ν_e monochromatic, $E_\nu \approx 900$ keV;
- Sm^* lifetime = $\sim 10^{-14}$ s, short enough to neglect all other interactions;
- Sm^* excitation energy = 961 KeV ($\approx E_\gamma$);
- only for γ in the direction of Sm^* recoil, angular momentum conservation implies Sm^* helicity = ν_e helicity = γ helicity = ± 1 [see box with 2 alternative hypotheses].

- Therefore, the method is:
 - [cannot measure directly the ν_e spin]
 - select and measure the γ 's emitted anti-parallel to the ν_e 's, i.e. in the same direction of the (${}^{152}\text{Sm}^*$);
 - measure their spin;
 - reconstruct the ν_e helicity.



the ν_e helicity : resonant scattering

- For γ of 961 keV, the dominant interaction with matter is the Compton effect; the Compton cross section is spin-dependent: the transmission is larger when the γ and e^- spin are parallel.
- Therefore, a strong and reversible \vec{B} (saturated iron) selects the polarized γ 's, producing an asymmetry between the two \vec{B} orientations.
- Need also to select only the γ 's polarized according to the ν_e spin, i.e. produced opposite to the ν_e 's \rightarrow use the method of *resonant scattering* in the Sm_2O_3 ring:

$$\gamma_1 + {}^{152}\text{Sm} \rightarrow {}^{152}\text{Sm}^* \rightarrow {}^{152}\text{Sm} + \gamma_2.$$
- [kinematics (next slide) : a nucleus at rest, excited by an energy E_0 , decays with a γ emission; the γ energy in the lab. is reduced by a factor $E_0/(2M)$].

- In general, γ_1 energy is degraded and NOT sufficient for Sm excitation (i.e. to produce γ_2).
- But, if γ_1 is anti-parallel to ν_e , the Sm^* recoils against ν_e . The resultant Doppler effect in the correct direction provides γ_1 of the necessary amount of extra energy ($E_{\nu} \approx E_{\gamma}$).
- In conclusion, only the γ 's anti-parallel to ν_e 's are detected, but those γ 's carry the information about ν_e helicity.

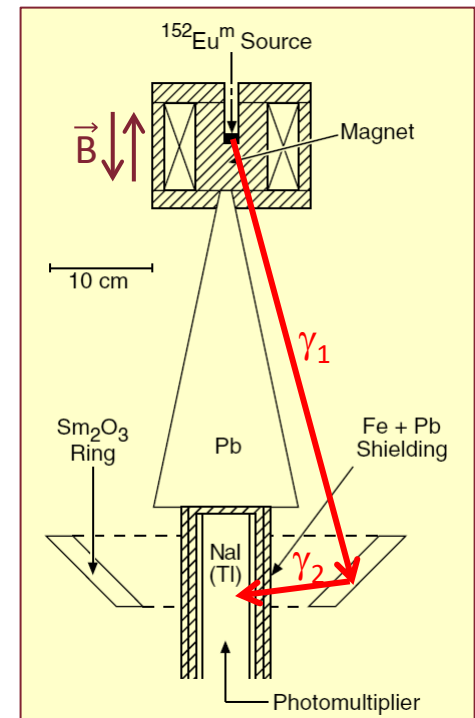

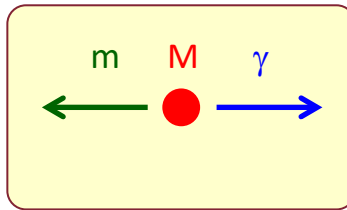

Kinematics

$$M \rightarrow m \gamma; \quad E_0 = M - m;$$

$$M \text{ sys. } \begin{cases} M = [M, & 0, & 0, 0]; \\ \gamma = [E_\gamma, & E_\gamma, & 0, 0]; \\ m = [M - E_\gamma, & -E_\gamma, & 0, 0]; \end{cases}$$

$$m^2 = (M - E_\gamma)^2 - E_\gamma^2 = M^2 + E_\gamma^2 - 2ME_\gamma - E_\gamma^2;$$

$$E_\gamma = \frac{M^2 - m^2}{2M} = \frac{M + m}{2M} E_0 = \\ = \frac{M + M - E_0}{2M} E_0 = E_0 \left(1 - \frac{E_0}{2M} \right).$$

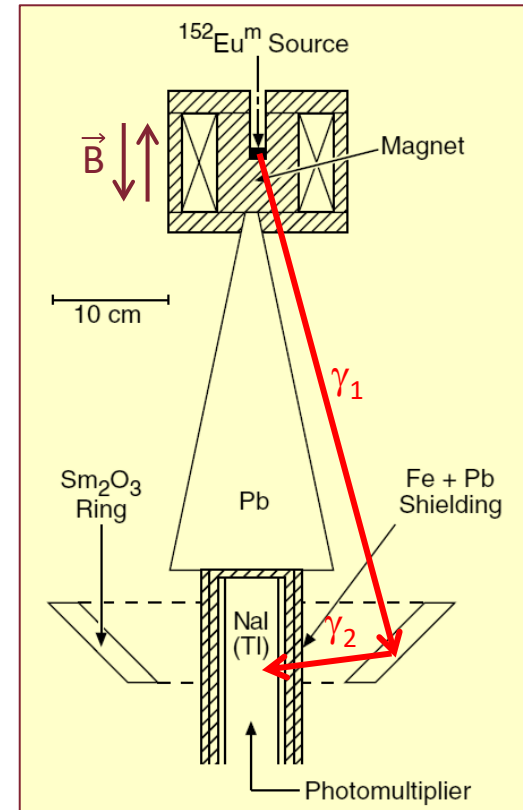

→ if the excited nucleus (M) is at rest, the energy of the γ in the lab. is smaller than the excitation energy E_0 ; therefore it is insufficient to excite another nucleus at rest; for this to happen, the excited nucleus has to move in the right direction with the appropriate energy.

weak decays : π^\pm

- The π^\pm is the lightest hadron; therefore it may only decay through semileptonic CC weak processes, like (consider only the +ve case, the -ve is similar) :

$$\pi^+ \rightarrow \mu^+ \nu_\mu; \quad \pi^+ \rightarrow e^+ \nu_e.$$

- In reality, it almost decays only into μ 's: the electron decay is suppressed by a factor $\approx 8,000$, NOT understandable, also because the $\pi \rightarrow e$ decay is favored by space phase.

- The reason is the **helicity**:

- in the π^+ reference frame, the momenta of the ℓ^+ and the ν_ℓ must be opposite;
- since the π^+ has spin 0, the spins of the ℓ^+ and the ν must also be opposite;
- therefore the two particles must have the same helicity;

- since the ν (a \sim massless particle) must have negative helicity, the ℓ^+ (a non-massless antiparticle) is also forced to have negative helicity;
- therefore the transition is suppressed by a factor $(1 - \beta_\ell)$;
- the e^+ is ultrarelativistic ($p_e \approx m_\pi / 2 \gg m_e$), while the μ^+ has small β [*compute it !!!*];
- therefore the decay $\pi \rightarrow e$ is strongly suppressed respect to $\pi \rightarrow \mu$.

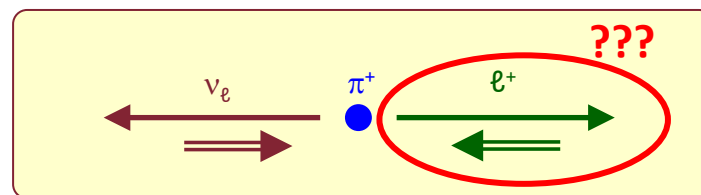

Kinematics (next slide) :

- $p_\ell = [(m_\pi^2 - m_\ell^2) / (2 m_\pi)]$;
- $\beta_e = (1 - 2.6 \times 10^{-5})$;
- $\beta_\mu = 0.38$.





SOLUTION : (more general)

Decay $M \rightarrow a b$. Compute $p = |\vec{p}_a| = |\vec{p}_b|$ in the CM system, i.e. the **system of M**:

$$\text{CM} \begin{cases} (M, & 0, & 0,0) \\ (\sqrt{m_a^2 + p^2}, & p, & 0,0); \\ (\sqrt{m_b^2 + p^2}, & -p, & 0,0) \end{cases}$$

$$p^2 = \frac{[M^2 - (m_a - m_b)^2][M^2 - (m_a + m_b)^2]}{4M^2}$$

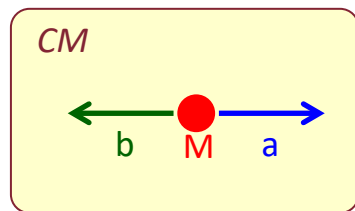

a) $m_a = m_b = m$; e.g. $K^0 \rightarrow \pi^0 \pi^0$;

$$p^2 = \frac{M^2 - 4m^2}{4} = \frac{(M+2m)(M-2m)}{4};$$

§ LHC

b) $m_a = m_b = 0$; e.g. $\pi^0 \rightarrow \gamma\gamma$, $H \rightarrow \gamma\gamma$;

$$p^2 = \frac{M^2}{4}; \quad p = \frac{M}{2};$$

§ LEP2

c) $m_a = m$; $m_b = 0$; e.g. $\pi^+ \rightarrow \mu^+ \nu_\mu$, $Z^* \rightarrow Z\gamma$;

$$p = \frac{M^2 - m^2}{2M} = \frac{M}{2} \left[1 - \left(\frac{m}{M} \right)^2 \right].$$

energy conservation : $M = \sqrt{m_a^2 + p^2} + \sqrt{m_b^2 + p^2}$;

$$2\sqrt{m_a^2 + p^2} \sqrt{m_b^2 + p^2} = M^2 - m_a^2 - m_b^2 - 2p^2;$$

$$4[m_a^2 m_b^2 + p^2(m_a^2 + m_b^2) + p^4] = (M^2 - m_a^2 - m_b^2)^2 + 4p^4 - 4p^2(M^2 - m_a^2 - m_b^2);$$

$$4p^2[(m_a^2 + m_b^2) + (M^2 - m_a^2 - m_b^2)] = -4m_a^2 m_b^2 + (M^2 - m_a^2 - m_b^2)^2;$$

$$4p^2 M^2 = [(M^2 - m_a^2 - m_b^2) + 2m_a m_b][M^2 - m_a^2 - m_b^2 - 2m_a m_b] = (\text{see above})$$



same info as in previous slide, only "easier" to see

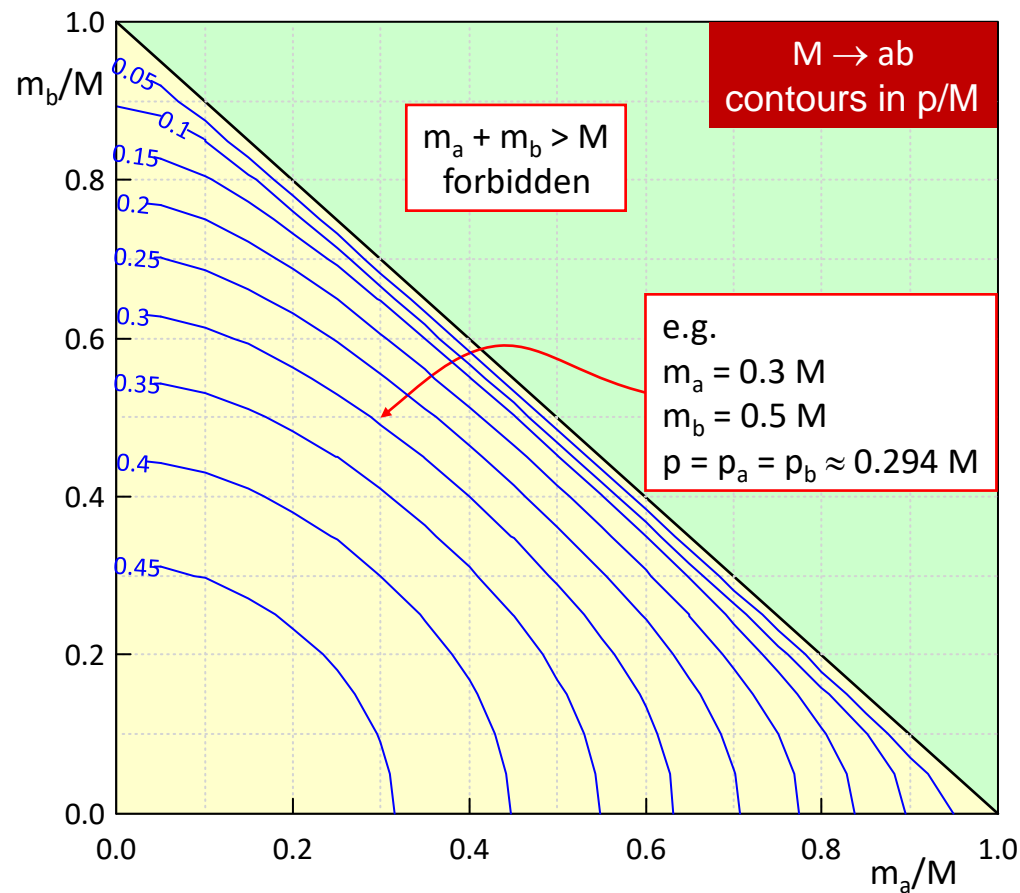
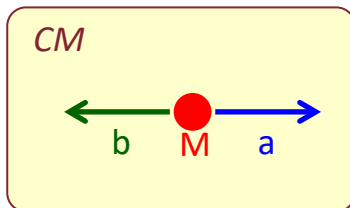

*the plot is only here to show
you how easy it is to produce
an apparently sophisticated
and professional plot.*

weak decays : $\pi^\pm \rightarrow (e^\pm \leftrightarrow \mu^\pm)$



Problem: compute the factor in the π^\pm decay between μ and e .

Assume for the decay $\pi \rightarrow \ell$ [$\ell = \mu$ or e] :

p = decay product momentum;

ρ_ℓ = dN/dE_{tot} = phase space factor;

dN = $Vp^2 dp d\Omega / (2\pi)^3$;

$(1 - \beta_\ell)$ = helicity suppression;

BR_ℓ = $const \times \rho_\ell \times (1 - \beta_\ell)$.

In this case the decay is isotropic. Then :

$\rho_\ell \propto p^2 dp / dE_{tot}$;

4-momentum conservation [use previous slide and save only terms ℓ -dependent]:

$$p_\ell = p_\nu = E_\nu \equiv p; \quad E_{tot} = m_\pi; \quad E_\ell = m_\pi - E_\nu = m_\pi - p;$$

$$p = \frac{m_\pi^2 - m_\ell^2}{2m_\pi} = \frac{E_{tot}}{2} - \frac{m_\ell^2}{2E_{tot}}; \quad \frac{dp}{dE_{tot}} = \frac{1}{2} + \frac{m_\ell^2}{2m_\pi^2} = \frac{m_\pi^2 + m_\ell^2}{2m_\pi^2};$$

$$\rho_\ell \propto \left(\frac{m_\pi^2 - m_\ell^2}{2m_\pi} \right)^2 \frac{m_\pi^2 + m_\ell^2}{2m_\pi^2} = \frac{(m_\pi^2 + m_\ell^2)(m_\pi^2 - m_\ell^2)^2}{4m_\pi^4};$$

$\rho_e > \rho_\mu$

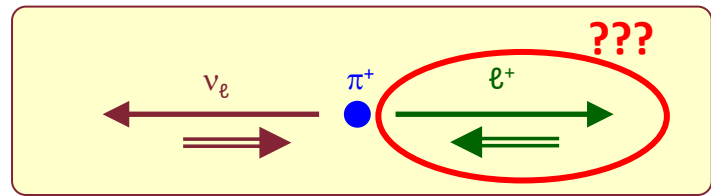

$$1 - \beta_\ell = 1 - \frac{p_\ell}{E_\ell} = 1 - \frac{p}{m_\pi - p} = \frac{m_\pi - 2p}{m_\pi - p}$$

$$= \frac{m_\pi - 2(m_\pi^2 - m_\ell^2)/(2m_\pi)}{m_\pi - (m_\pi^2 - m_\ell^2)/(2m_\pi)} = \frac{2m_\ell^2}{m_\pi^2 + m_\ell^2};$$

$$BR_\ell \propto (m_\pi^2 + m_\ell^2)(m_\pi^2 - m_\ell^2)^2 \frac{m_\ell^2}{m_\pi^2 + m_\ell^2}$$

$$\propto m_\ell^2 (m_\pi^2 - m_\ell^2)^2$$

$1 - \beta_e \ll \ll 1 - \beta_\mu$

For electrons, $m_e \ll m_\pi$, so :

$$\frac{BR(\pi^+ \rightarrow e^+ \nu_e)}{BR(\pi^+ \rightarrow \mu^+ \nu_\mu)} = \left(\frac{m_e}{m_\mu} \frac{m_\pi^2 - m_e^2}{m_\pi^2 - m_\mu^2} \right)^2 \approx 1.28 \times 10^{-4}$$

Experimentally, it is measured

$$\frac{BR(\pi^+ \rightarrow e^+ \nu_e)}{BR(\pi^+ \rightarrow \mu^+ \nu_\mu)} = 1.23 \times 10^{-4}$$

i.e. $N(\pi \rightarrow \mu) \approx 8,000 N(\pi \rightarrow e)$

weak decays : μ^\pm

- Consider a famous experiment (Anderson et al., 1960) :

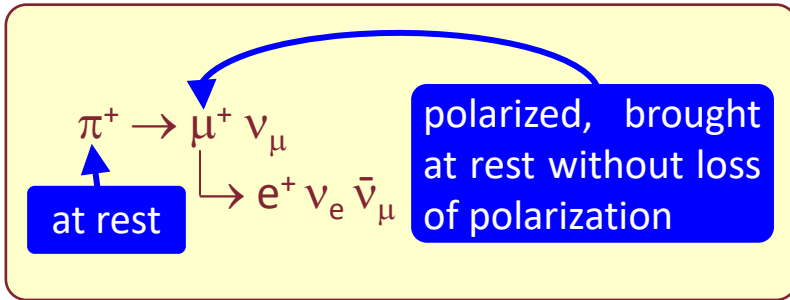

- In the μ^+ ref. frame (=LAB), this configuration is clearly preferred :

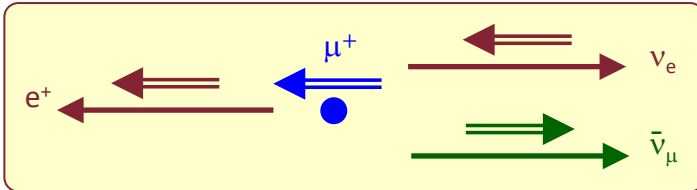

- In this angular configuration, both space and angular momentum are conserved, the particles are left- and the anti-particles right-handed.
- From the figure :
 - few e^+ directly from π^+ decay, shown

in the right part ($\int \mu / \int e \approx 8,000$);

- the electron energy is the only measurable variable;
- kinematical considerations show that it is correlated with the angular variables, and that the value $E_e \approx m_\mu / 2$ is possible only for parallel ν 's.
- the distribution clearly shows the parity violation in muon decay.

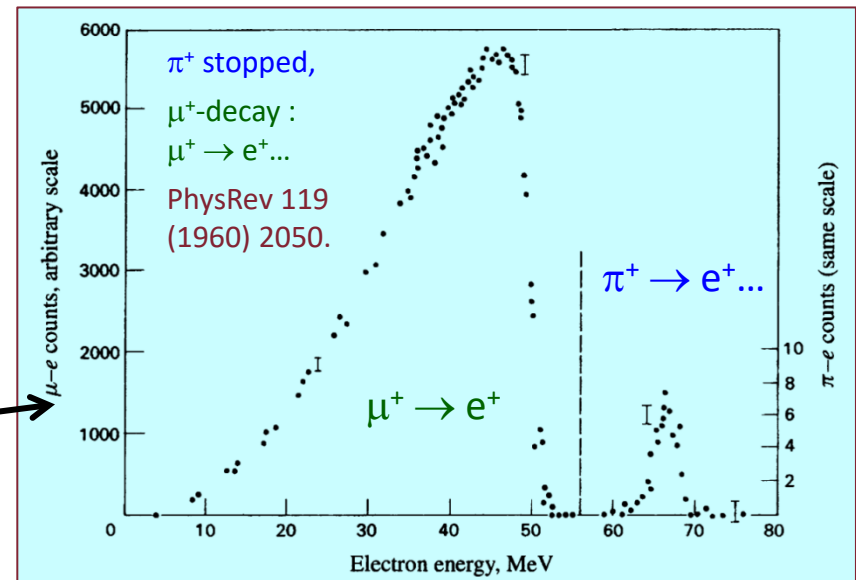

weak decays : \mathbb{C} , \mathbb{P} in μ decay



Apply the operators \mathbb{C} and \mathbb{P} to the previous cases :

\mathbb{C}

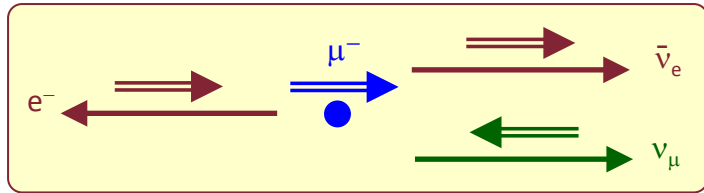

=

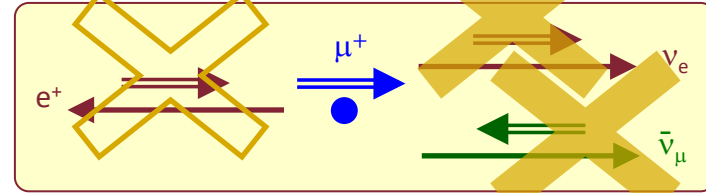

\mathbb{P}

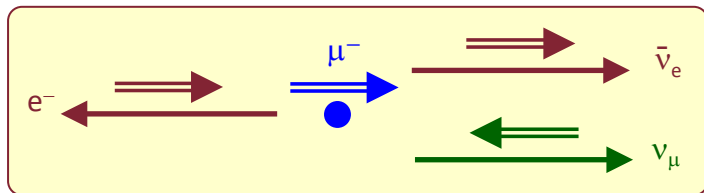

=

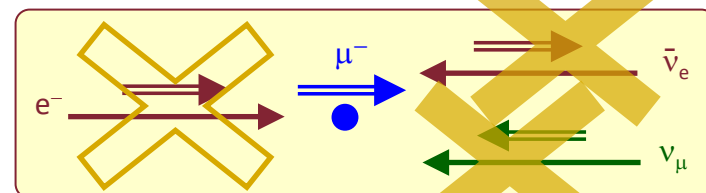

\mathbb{CP}

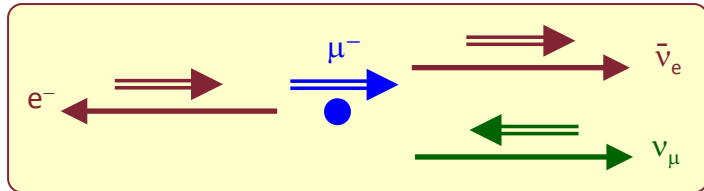

=

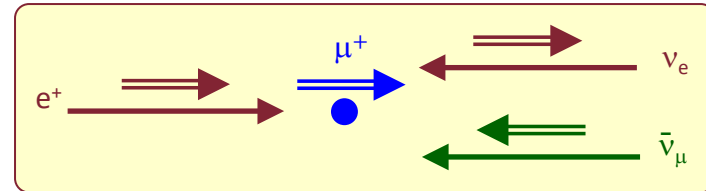

- [the "X" shows the forbidden – not existent – particles]
- both \mathbb{C} and \mathbb{P} alone transforms the decay into non-existent processes (we say "both \mathbb{C} and \mathbb{P} separately are not conserved in this process");
- instead, the application of \mathbb{CP} turns a μ^- decay (which does exist) into a μ^+ decay (which also exists) \rightarrow " \mathbb{CP} is conserved in this process".



decay $\pi^0 \rightarrow \gamma\gamma$: L-transf.

L-transf $\begin{cases} E = \gamma(E^* + \beta p_l^*); \\ p_l = \gamma(p_l^* + \beta E^*); \\ p_T = p_T^*; \end{cases}$

NB: L-transf.
CM \rightarrow Lab.

$m \equiv m_{\pi^0}; \quad \beta \equiv \frac{p_{\pi^0}}{E_{\pi^0}}; \quad \gamma \equiv \frac{E_{\pi^0}}{m_{\pi^0}}.$

In CM, π^0
at rest.

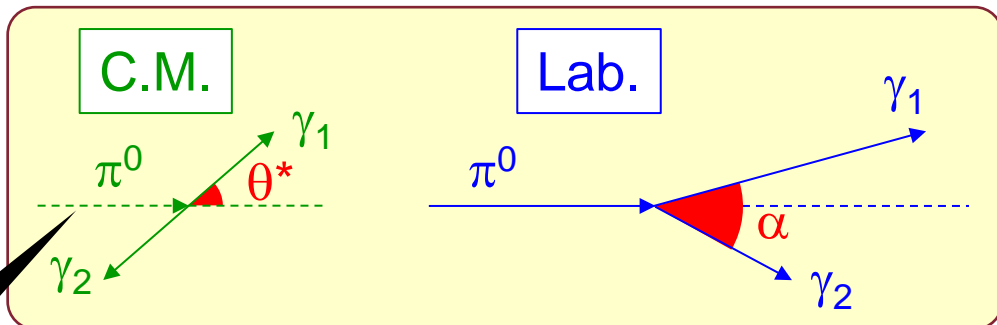

	C.M.	Lab.
π^0	$m\{1,0,0,0\}$	$m\{\gamma, \beta\gamma, 0, 0\}$
γ_1	$\frac{m}{2}\{1, \cos\theta^*, \sin\theta^*, 0\}$	$\frac{m}{2}\{\gamma(1 + \beta\cos\theta^*), \gamma(\cos\theta^* + \beta), \sin\theta^*, 0\}$
γ_2	$\frac{m}{2}\{1, -\cos\theta^*, -\sin\theta^*, 0\}$	$\frac{m}{2}\{\gamma(1 - \beta\cos\theta^*), \gamma(-\cos\theta^* + \beta), -\sin\theta^*, 0\}$

• the $\pi^0 \rightarrow \gamma\gamma$ decay is an e.m. process; it is here just for convenience;

• see also FNSN1, § Cinematica, 22-26.

[...] = 1

$$\cos\alpha = 1 - 2\sin^2\frac{\alpha}{2} = \frac{\vec{p}_1^{\text{Lab}} \cdot \vec{p}_2^{\text{Lab}}}{E_1^{\text{Lab}} E_2^{\text{Lab}}} = \frac{\chi^2(\beta^2 - \cos^2\theta^*) - \sin^2\theta^* [\chi^2(1 - \beta^2)]}{\chi^2(1 - \beta^2 \cos^2\theta^*)} = \frac{\beta^2(1 + \sin^2\theta^*) - 1}{1 - \beta^2 \cos^2\theta^*};$$

for a γ :
 $|\vec{p}| = E$

$$\sin^2\frac{\alpha}{2} = -\frac{1}{2} \left(\frac{\beta^2(1 + \sin^2\theta^*) - 1}{1 - \beta^2 \cos^2\theta^*} - \frac{1 - \beta^2 \cos^2\theta^*}{1 - \beta^2 \cos^2\theta^*} \right) = \frac{\beta^2 + \beta^2 - 2}{-2(1 - \beta^2 \cos^2\theta^*)} = \frac{1}{\gamma^2(1 - \beta^2 \cos^2\theta^*)}.$$

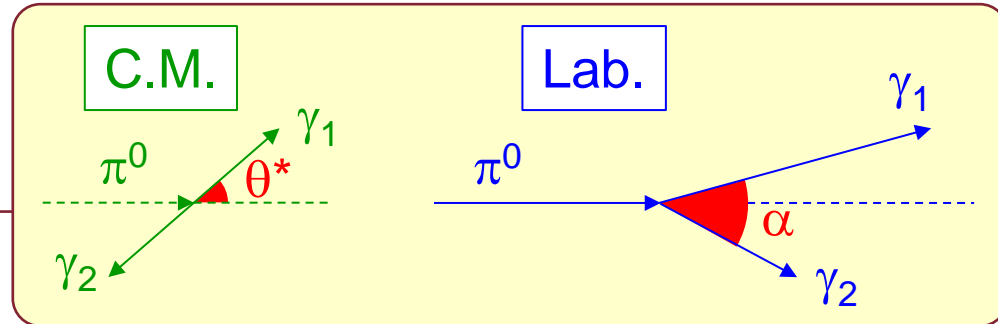
decay $\pi^0 \rightarrow \gamma\gamma$: angle α 

$$\sin^2 \frac{\alpha}{2} = \frac{1}{\gamma^2 (1 - \beta^2 \cos^2 \theta^*)};$$

$$\xrightarrow[\theta^*=90^\circ, \cos\theta^*=0]{\text{---}} [\text{---}\leftrightarrow\text{---}] \sin^2 \frac{\alpha}{2} \Big|_{\min} = \frac{1}{\gamma^2} = \left(\frac{m_{\pi^0}}{E_{\pi^0}} \right)^2 \rightarrow \alpha_{\min} \cong \frac{2m_{\pi^0}}{E_{\pi^0}};$$

$$\xrightarrow[\theta^*=0^\circ, \cos\theta^*=1]{\text{---}} [\text{---}\leftrightarrow\leftrightarrow\text{---}] \sin^2 \frac{\alpha}{2} \Big|_{\max} = \frac{1}{\gamma^2 (1 - \beta^2)} = 1 \rightarrow \alpha_{\max} = 180^\circ;$$

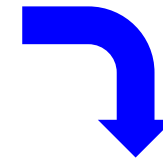
 $f(\theta^*)$

$\pi^0 \quad m\{\gamma, \beta\gamma, 0; 1\}$

 $\alpha|_{\min} [\cos\theta^* = 0]$

$m\{\gamma, \beta\gamma, 0; 1\}$

 $\alpha|_{\max} [\cos\theta^* = 1]$

$m\{\gamma, \beta\gamma, 0; 1\}$

$\gamma_1 \quad \frac{m}{2} \{\gamma(1 + \beta \cos\theta^*), \gamma(\cos\theta^* + \beta), \sin\theta^*; 0\}$

$\frac{m}{2} \{\gamma, \beta\gamma, 1; 0\}$

$\frac{m}{2} \{\gamma(1 + \beta), \gamma(1 + \beta), 0; 0\}$

$\gamma_2 \quad \frac{m}{2} \{\gamma(1 - \beta \cos\theta^*), \gamma(-\cos\theta^* + \beta), -\sin\theta^*; 0\}$

$\frac{m}{2} \{\gamma, \beta\gamma, -1; 0\}$

$\frac{m}{2} \{\gamma(1 - \beta), \gamma(-1 + \beta), 0; 0\}$

decay $\pi^0 \rightarrow \gamma\gamma : \mathcal{P}(\alpha)$ 

$\text{spin}(\pi^0) = 0 \rightarrow \mathcal{P}(\cos\theta^*) = \text{flat} = 1/2.$

Therefore :

$$E_{\gamma}^{1,2} = \frac{m\gamma}{2}(1 \pm \beta\cos\theta^*) \rightarrow \frac{dE_{\gamma}^{1,2}}{d\cos\theta^*} = \pm \frac{m\beta\gamma}{2} \rightarrow$$

$$\mathcal{P}(E_{\gamma}^{1,2}) = \mathcal{P}(\cos\theta^*) \left/ \left| \frac{dE_{\gamma}^{1,2}}{d\cos\theta^*} \right| \right. = \frac{1}{2} \frac{2}{m\beta\gamma} = \frac{1}{m\beta\gamma} = \frac{1}{p_{\pi^0}}$$

$$\text{flat in } \left[\frac{m\gamma}{2}(1-\beta), \frac{m\gamma}{2}(1+\beta) \right].$$

$$\mathcal{P}(\alpha) = \frac{1}{4\beta\gamma \sin^2(\alpha/2) \sqrt{\gamma^2 \sin^2(\alpha/2) - 1}} \cos(\alpha/2)$$

[no proof, \rightarrow FNSN1, §cinematica, 26].

nota bene –

mutatis mutandis, similar kinematics also for $H \rightarrow \gamma\gamma$ [$\text{spin}(\pi^0) = \text{spin}(H) = 0$].

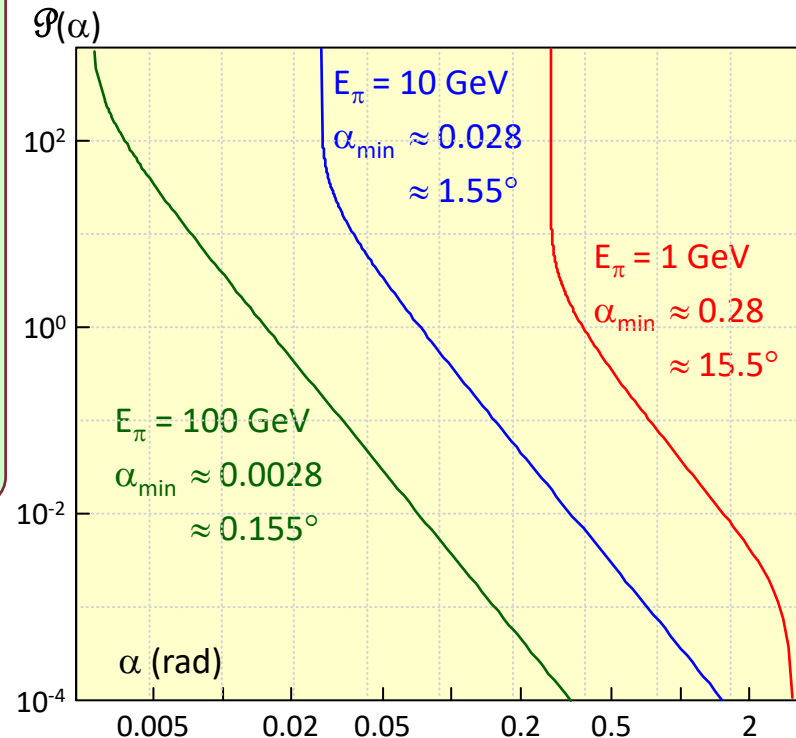
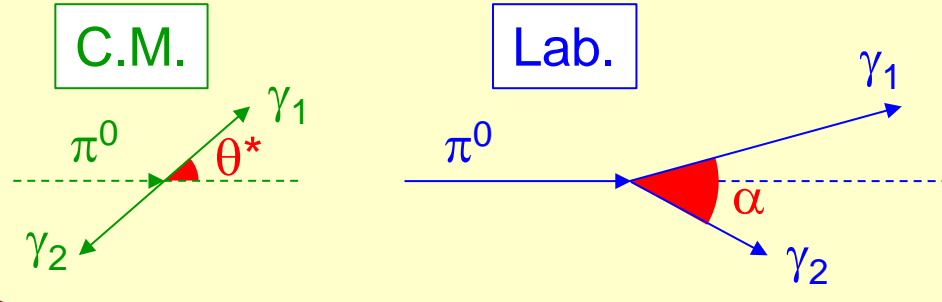

β decay : introduction

- For point-like fermions, CC is " $V - A$ ", both for leptons and quarks [*the only difference for hadrons being the CKM "rotation", see later*];
- however, nucleons and hyperons ($p, n, \Lambda, \Sigma, \Xi, \Omega$) are bound states of non-free quarks;
- for low Q^2 processes, the "spectator model" (in this case the free quark decay) is an unrealistic approximation;
- strong interaction corrections are important \rightarrow modify $V - A$ dynamics;
- the standard approach, due to Fermi, is to produce a parameterization, based on the vector properties of the current (S-P-V-A-T, see) and then compute \leftrightarrow measure the coefficients;
- pros : quantitative theory, which reproduces the experiments well;

- cons : lack of deep understanding of the parameters.

the simple and successful approach, used for point-like decays, is not valid here, because of strong interaction corrections; those are (possibly understood, but) non-perturbative and impossible to master with present-day math; same as chemistry \leftrightarrow electromagnetism.

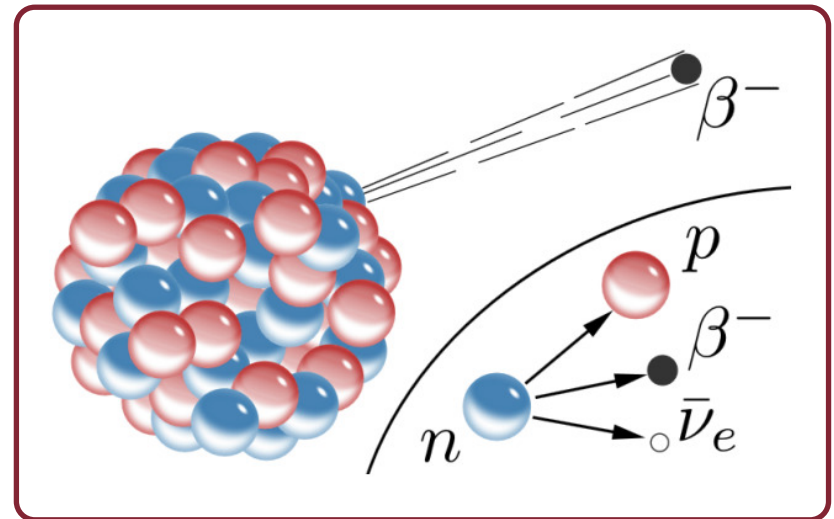

β decay : Fermi \leftrightarrow Gamow-Teller

- In Fermi theory, CC currents were classified according to the properties of the transition operator.
- In neutron β -decay, the e - $\bar{\nu}$ pair may be created as a spin singlet ($S=0$) or triplet ($S=1$). In case of NO orbital angular momentum, there are two possibilities to conserve the total angular momentum :
 - Fermi transitions [F], $S=0$, $\Delta J_{e\nu}=0$: the direction of the spin of the nucleon remains unchanged; in modern language, [it can be shown that] the interaction takes place with vector coupling G_V ;
 - Gamow-Teller transitions [G-T], $S=1$, $\Delta J_{e\nu} = 0, \pm 1$: the direction of the spin of the nucleon is turned upside down (it "flips"); [...] the transition happens with axial-vector coupling G_A .
- In principle, F and G-T processes are completely different : there is no a-priori reason why the coupling should be similar or even related.

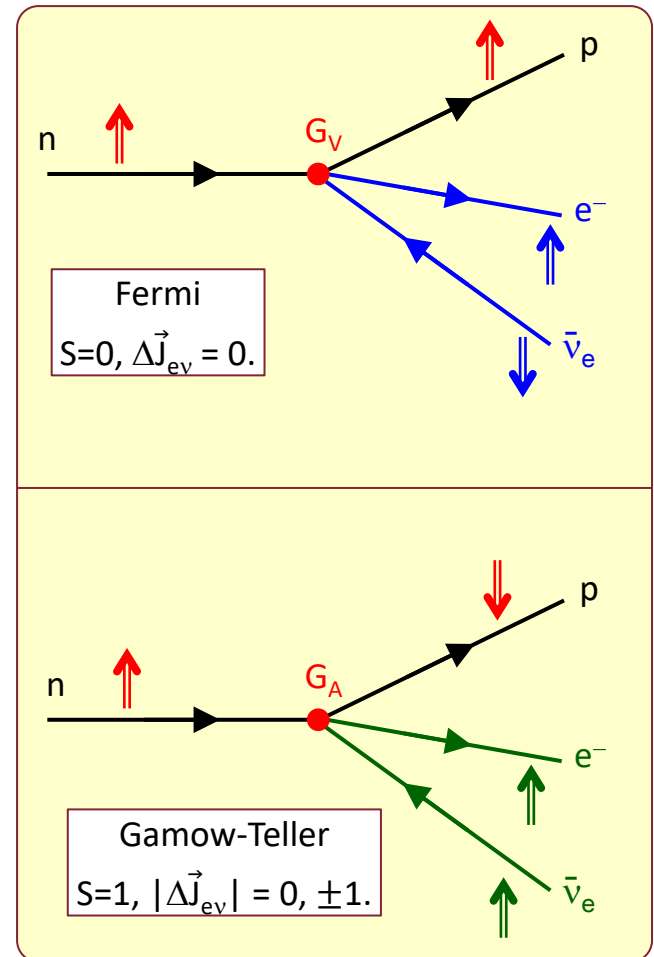

β decay : S, P, V, A, T

- Study the neutron β decay; assume :
 - p and n are spin- $\frac{1}{2}$ fermions;
 - e^\pm and ν are spin- $\frac{1}{2}$ fermions, but the ν exists only with helicity = -1 .

- Then, the most general matrix element for the four-body interaction is

$$\mathcal{M}_{fi} = \frac{G_F}{\sqrt{2}} \sum_j C_j [\bar{u}_p O_j u_n] [\bar{u}_e O_j (1 - \gamma_5) u_\nu],$$

- G_F : the overall coupling;
- $\bar{u}_{p,n,e,\nu}$ ($u_{p,n,e,\nu}$) : creation (destruction) operators for p, n, e, ν ;
- $(1 - \gamma_5)$: projector of $-ve$ ν helicity;
- C_j : sum coefficients (adimensional free parameters, *possibly of order 1*);
- O_j : current operators with given vector properties : **S** = scalar, **P** = pseudo-scalar, **V** = vector, **A** = axial-vector, **T** = tensor.

- For β -decay, the pseudo-scalar term is irrelevant : P can only be built from the proton velocity v_p in the neutron rest frame, which are depressed by v_p/c ;
- For the other four terms, the angular distributions are [BJ 399, YN1 561] ($1, \frac{1}{3}$ for singlet and triplet, β =electron velocity) :

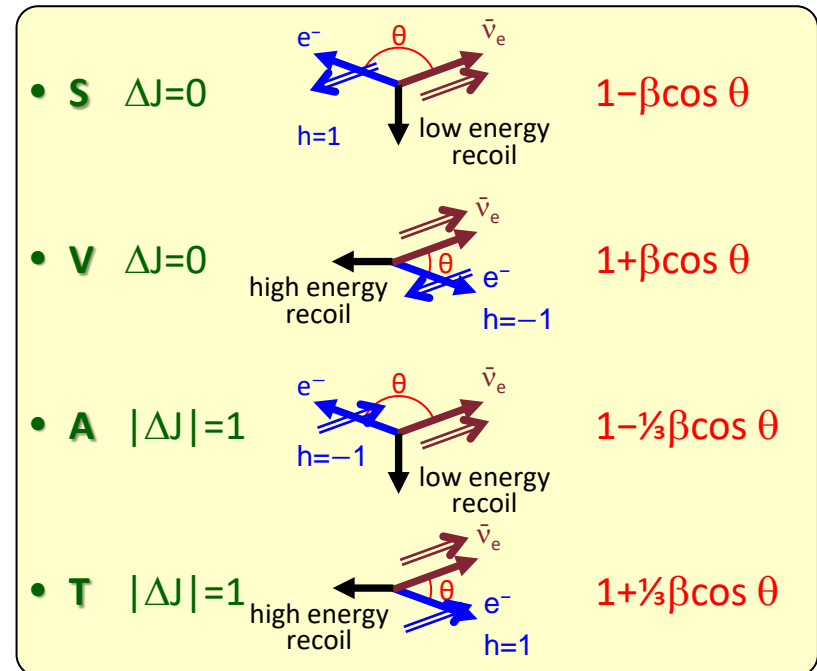

β decay : V, A

- From comparison with data, some terms can be excluded:
 - (S and V) are Fermi transitions : they cannot be both present, due to the lack of observed interference between them;
 - (A and T) are G-T transitions : same argument holds;
 - the angular distributions of the electrons are only consistent with V for F and A for G-T.

- So the matrix element becomes :

$$\mathcal{M}_{fi} = \frac{G_F}{\sqrt{2}} \left[\bar{u}_p \gamma^\mu (C_V + C_A \gamma_5) u_n \right] \left[\bar{u}_e \gamma^\mu (1 - \gamma_5) u_\nu \right],$$

- the value of C_V can be measured by comparing (composite) hadrons with (free, pure V-A) leptons; it turns out

$$C_V \approx 1.$$

- The value of C_A^2 can be measured from the relative strength of F and G-T, by comparing neutron β -decay with a pure Fermi ($^{14}\text{O} \rightarrow ^{14}\text{N} e^+ \nu$); for β decay:

$$|C_A| \cong 1.267.$$

- The sign of C_A could be measured from the polarization of the protons (a very difficult measurement); in practice from the interference between F and G-T in polarized neutrons decays :

$$C_A \cong -1.267.$$

Fermi did not know about parity violation, and would have written different matrix elements for his ("Fermi") transitions.

However, the final result for leptons and free quarks is very similar to his original proposal, but the factor $(1-\gamma_5)$:

$$\mathcal{M}_{fi} = \frac{G}{\sqrt{2}} \left[\bar{u}_p \gamma^\mu (1 - \gamma_5) u_n \right] \left[\bar{u}_e \gamma^\mu (1 - \gamma_5) u_\nu \right].$$



- For the leptonic current, $C_A = -C_V$. These processes are much simpler, because leptons, unlike quarks, exist as free particles.
- The hadrons can be treated similarly when their partons (= quarks) interact as "quasi-free" particles, (e.g. DIS + the "spectator approximation" [$\S v$, $\S Collider$]).
- In this case (e.g. in ν DIS), the CC exhibits for hadrons the same "V-A" structure as for leptons.
- However, at low Q^2 , when hadrons behave as coherent particles and not as parton containers, the similarity appears to be broken.
- In low Q^2 processes, [it can be shown that] the vector part of the hadronic current stays constant (CVC, conserved vector current), while the axial part is broken (PCAC^(*), "partially conserved axial current").
- In baryon β -decays, it is measured :
 - $n \rightarrow p e \bar{\nu}_e$, $-C_A/C_V = 1.267$
 - $\Lambda \rightarrow p \pi^-, n \pi^0$ = +.718
 - $\Sigma^- \rightarrow n e \bar{\nu}_e$ = -0.340
 - $\Xi^- \rightarrow \Lambda e^- \bar{\nu}_e$ = +0.25
 - [high Q^2 (free quarks) = 1].

$$\mathcal{M}_{fi} \propto \left[\bar{u}_p \gamma^\mu \left(1 - \frac{C_A}{C_V} \gamma_5 \right) u_n \right] \left[\bar{u}_e \gamma^\mu (1 - \gamma_5) u_\nu \right]$$

(*) at the time, they preferred to say "partially conserved" instead of "badly broken"; it now seems that the acronym "PCAC" is slowly disappearing from the texts : you are kindly requested to forget the term "PCAC" forever.

quark decays

- At quark level and high Q^2 , the beautiful structure "V-A" seems restored: quarks behave as free, point-like particles, exactly like the leptons [*§ Collider*].

- However, with more accurate data, some discrepancies appear, not due to strong interactions (see boxes).
- An apparent violation of CC universality? A mistake?

(continue...)

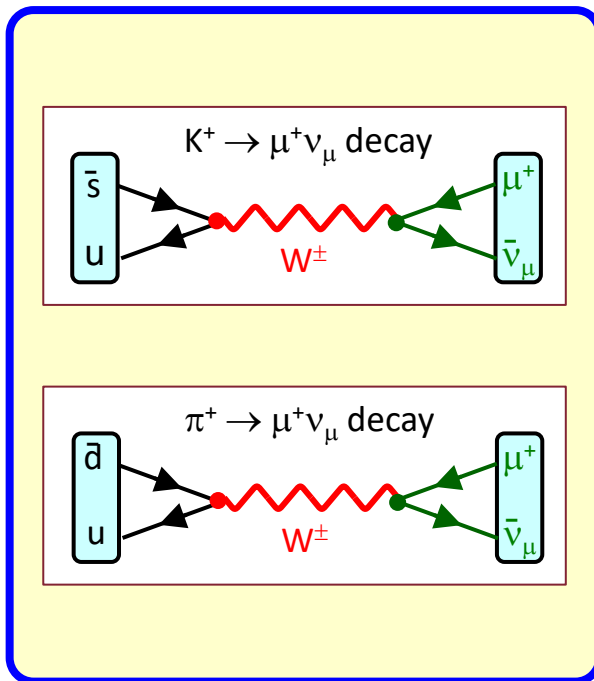

It is measured :

$$\frac{G_F^{2'} \left[\begin{array}{l} K^+ \rightarrow \mu^+ \nu_\mu, \\ \Delta S = 1 \end{array} \right]}{G_F^{2''} \left[\begin{array}{l} \pi^+ \rightarrow \mu^+ \nu_\mu, \\ \Delta S = 0 \end{array} \right]} \approx 0.05;$$

$$\frac{\Gamma \left[\begin{array}{l} \Sigma^- \rightarrow n e^- \bar{\nu}_e, \\ \Delta S = 1 \end{array} \right]}{\Gamma \left[\begin{array}{l} n \rightarrow p e^- \bar{\nu}_e, \\ \Delta S = 0 \end{array} \right]} \approx 0.05.$$

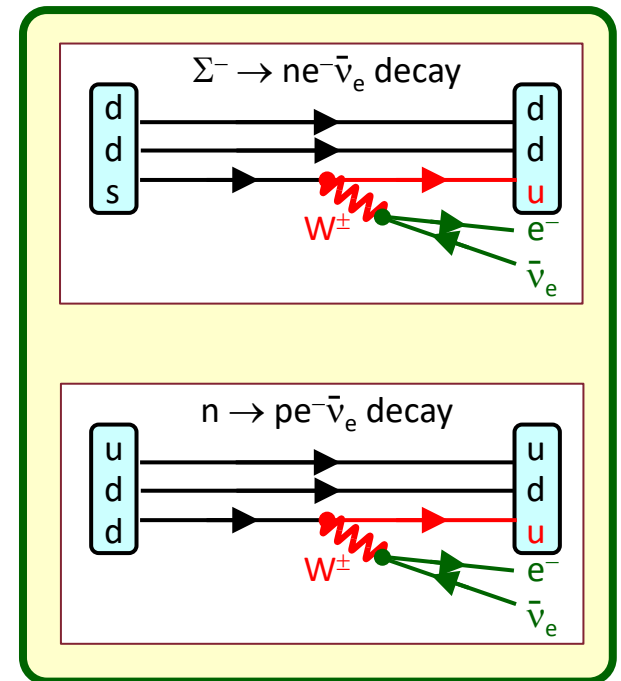

quark decays : Cabibbo theory

(... continue ...)

Even tiny, but well measured effects seem to contradict the universality; " G_F " is slightly larger for leptons :

$$G_F[\mu^- \rightarrow e^- \bar{\nu}_e \nu_\mu] \approx 1.166 \times 10^{-5} \text{ GeV}^{-2};$$

$$G_F \begin{cases} n \rightarrow pe^- \bar{\nu}_e, \\ \text{i.e. } d \rightarrow ue^- \bar{\nu}_e \end{cases} \approx 1.136 \times 10^{-5} \text{ GeV}^{-2}.$$

In 1963 N. Cabibbo [at the time much younger than in the image], invented a theory to explain the effect : the "Cabibbo angle" θ_c :

$$\begin{pmatrix} d' \\ s' \end{pmatrix} = \begin{pmatrix} \cos\theta_c & \sin\theta_c \\ -\sin\theta_c & \cos\theta_c \end{pmatrix} \begin{pmatrix} d \\ s \end{pmatrix}.$$

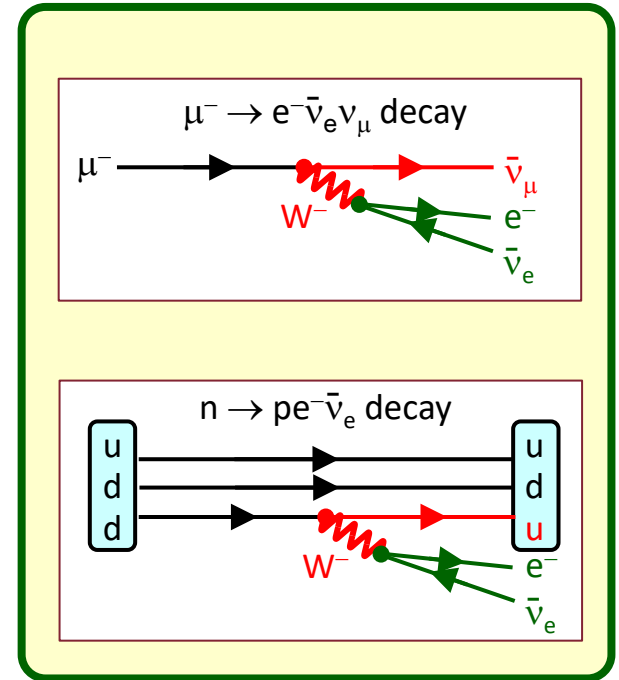
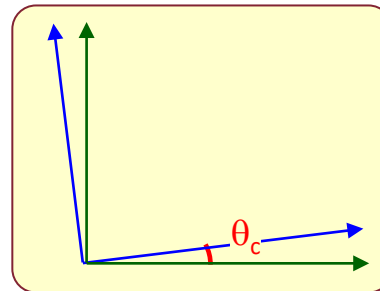

quark decays : Cabibbo "rotation"

The idea was the following :

- the hadrons are built up with quarks **u d s** (**c b t** not yet discovered);
- however, in the CC processes, the quarks (d s) – same quantum numbers but S – mix together (= "rotate" by an angle θ_c), in such a way that the CC processes see "rotated" quarks (d' s') :

$$\begin{pmatrix} d' \\ s' \end{pmatrix} = \begin{pmatrix} \cos\theta_c & \sin\theta_c \\ -\sin\theta_c & \cos\theta_c \end{pmatrix} \begin{pmatrix} d \\ s \end{pmatrix}.$$

- therefore, respect to the strength of the leptonic processes (no mix), the ud

coupling (actually ud') is decreased by a factor $\cos \theta_c$ and the us coupling (actually us') by a factor $\sin \theta_c$;

- therefore the processes with $\Delta S = 0$ happen $\propto \cos^2\theta_c$ and those with $\Delta S = 1$ $\propto \sin^2\theta_c$;
- even processes $\propto \sin^4\theta_c$ may happen (e.g. in the charm sector, see §3), when two "Cabibbo suppressed" couplings are present in the same process;
- all the anomalies come back under control if

$$\sin^2\theta_c \approx .03, \cos^2\theta_c \approx .97.$$

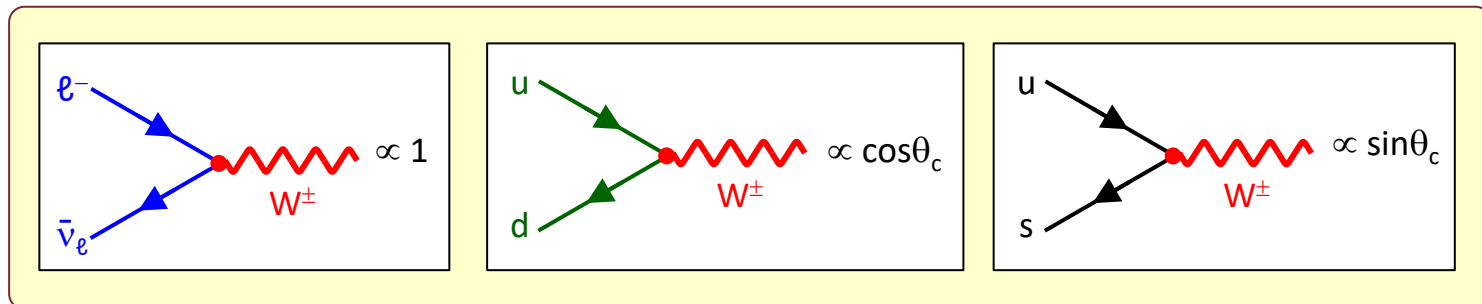

quark decays : GIM mechanism

In this context the GIM mechanism was invented to explain the absence of FCNC:

• data, at the time not understandable :

$$\left. \begin{aligned} \text{BR}(K^0 \rightarrow \mu^+ \mu^-) &= 7 \times 10^{-9} \\ \text{BR}(K^+ \rightarrow \mu^+ \nu_\mu) &= 0.64 \end{aligned} \right\} \left[\begin{array}{l} \text{already} \\ \text{mentioned} \end{array} \right];$$

$$\left. \begin{aligned} \text{BR}(K^+ \rightarrow \pi^+ \nu \bar{\nu}) &= (1.5_{-0.9}^{+1.3}) \times 10^{-10} \\ \text{BR}(K^+ \rightarrow \pi^0 e^+ \nu_e) &= (4.98 \pm 0.07) \times 10^{-2} \end{aligned} \right\}$$

i.e. a factor $\sim 10^{-8}$ between NC and CC decays;

- if the Z, carrier of NC, see the same quark mixture as the W^\pm in CC, then the NC decay would be suppressed only by a factor 5%;
- the idea was to introduce a fourth quark, called c (charm), with charge $\frac{2}{3}$, as the u quark; this solves the FCNC problem;
- the c quark was discovered in 1974 [see § 3].

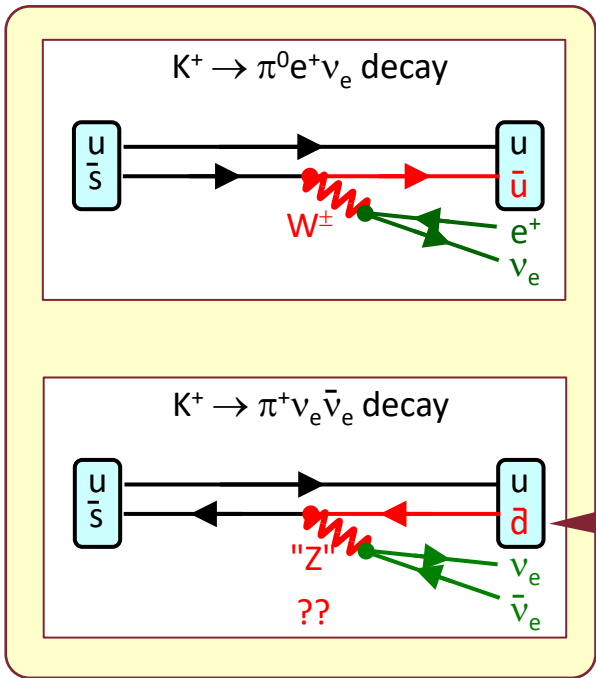

quark decays : no FCNC

In the GIM mechanism, NC contain four hadronic terms, coupled with the Z.

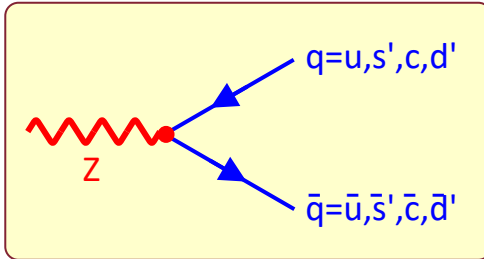

Assume Cabibbo theory and sum all terms:

$$\begin{aligned}
 & u\bar{u} + d'\bar{d}' + c\bar{c} + s'\bar{s}' = \\
 & = u\bar{u} + (d\cos\theta_c + s\sin\theta_c)(\bar{d}\cos\theta_c + \bar{s}\sin\theta_c) + \\
 & + c\bar{c} + (s\cos\theta_c - d\sin\theta_c)(\bar{s}\cos\theta_c - \bar{d}\sin\theta_c) = \\
 & = u\bar{u} + c\bar{c} + d\bar{d} + s\bar{s} + "0". \quad (!!!)
 \end{aligned}$$

the "non-diagonal" terms, which induce FCNC, disappear.

Why ($K^0 \rightarrow \mu^+\mu^-$) is small, but NOT = 0 ?

Look at the 1st "box diagram":

- technically a 2nd order ($\propto g^4 \sin\theta_c \cos\theta_c$) CC;
- same final state as a 1st order FCNC;
- incompatible with data (BR too large);

- cured by the 2nd diagram with a c quark, whose contribution cancels the first in the limit $m_c \rightarrow m_u$.

The cancellation depends on m_c . The decay ($K^0 \rightarrow \mu^+\mu^-$) puts limits on m_c between 1 and 3 GeV [$J/\psi \rightarrow 2m_c \approx 3.1$ GeV, see].

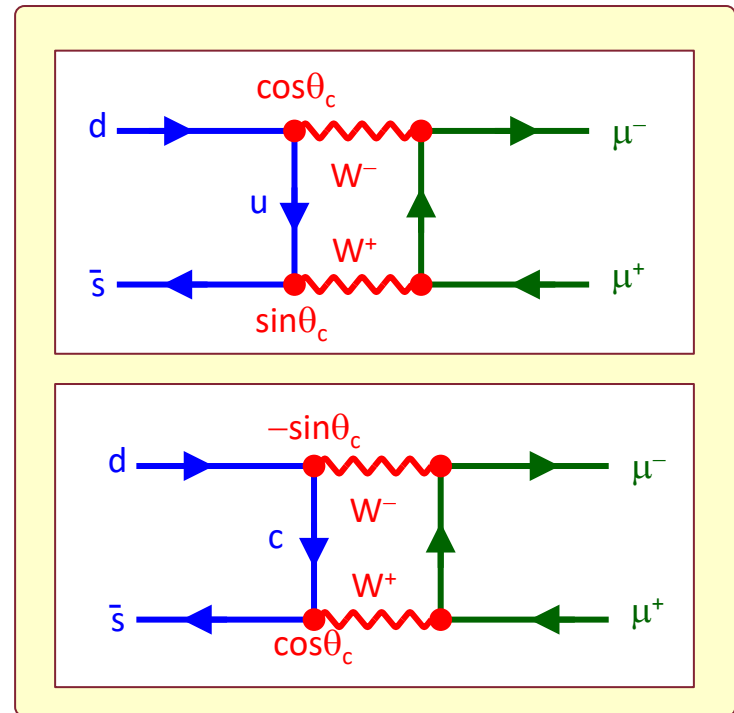

quark decays : the third generation

In 1973, Kobayashi and Maskawa extended the Cabibbo scheme to a new generation of quarks : the new mixing matrix (analogous to the Euler matrix in ordinary space) is a three-dimension unitary matrix, with three real parameters ("Euler angles") and one imaginary phase :

$$\begin{pmatrix} u \\ d' \end{pmatrix}_L \quad \begin{pmatrix} c \\ s' \end{pmatrix}_L \quad \begin{pmatrix} t \\ b' \end{pmatrix}_L \quad \Leftrightarrow W^\pm$$

$$\begin{pmatrix} d' \\ s' \\ b' \end{pmatrix} = \begin{pmatrix} V_{ud} & V_{us} & V_{ub} \\ V_{cd} & V_{cs} & V_{cb} \\ V_{td} & V_{ts} & V_{tb} \end{pmatrix} \begin{pmatrix} d \\ s \\ b \end{pmatrix}$$

The matrix is known as **CKM** (*Cabibbo-Kobayashi-Maskawa*) matrix.

K-M observed that the \mathbb{CP} violation, already discovered, is automatically generated by the matrix, when the imaginary phase is non-zero.

In addition to the \mathbb{CP} -violation, the nine elements of the CKM matrix govern the flavor changes in CC processes.

The measurement of the elements and the check of the unitarity relations is an important subject of physics studies : e.g. if some element is too small, this could be an indication of term(s) missing in the sum, i.e. the presence of a next generation of quarks.

[A discussion of the CKM matrix in §5.]



Makoto Kobayashi

Toshihide Maskawa





- The quark flavor changes only as a consequence of a weak CC interaction (*).
- Each type of quark can convert into each other with charge ± 1 , emitting or absorbing a W boson.
- The coupling is modulated by the strength of the mixing (the width of the line in fig.); in the SM it is described by the V_{CKM} matrix [§5].

(*) since FCNC do NOT [seem to] exist, NC processes – with Z mediators – do NOT play any role in flavor decays.

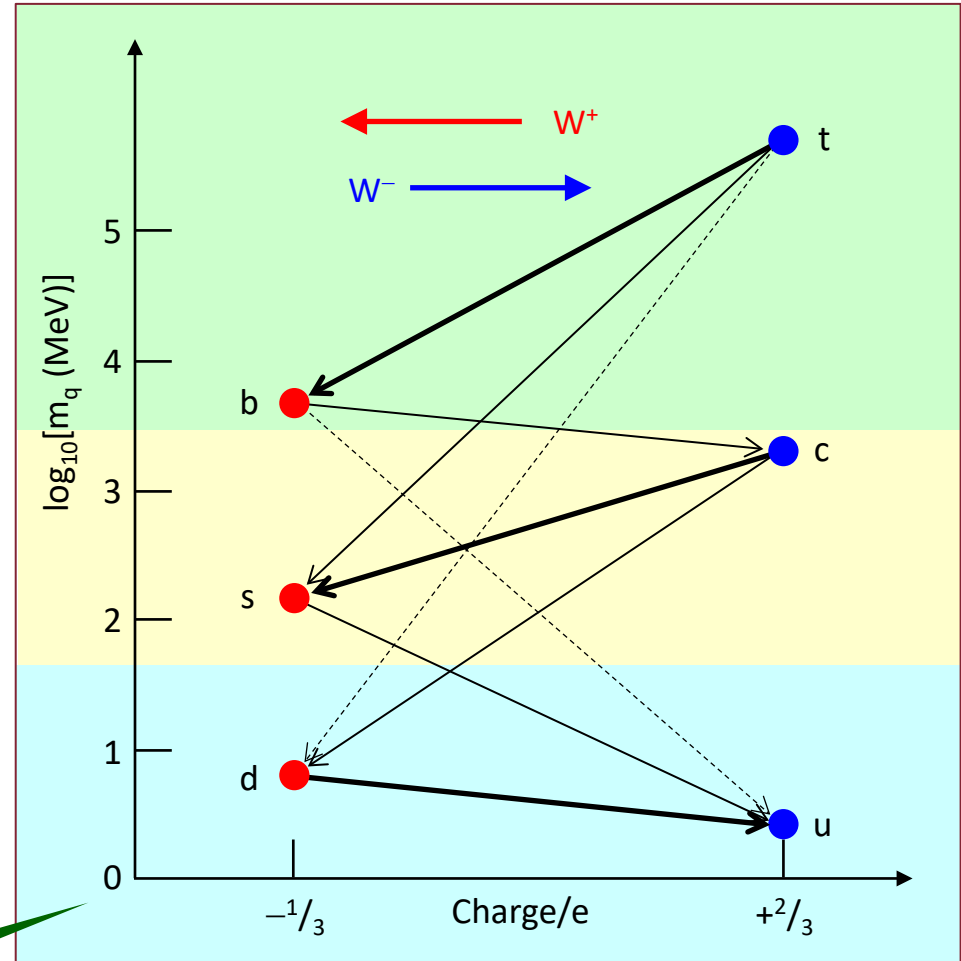

+ the equivalent table for \bar{q} 's.



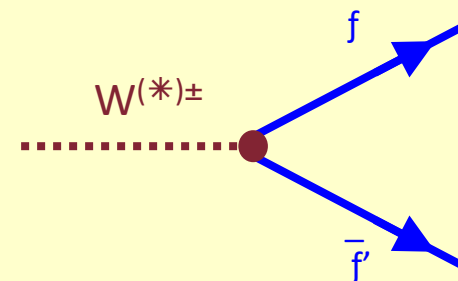
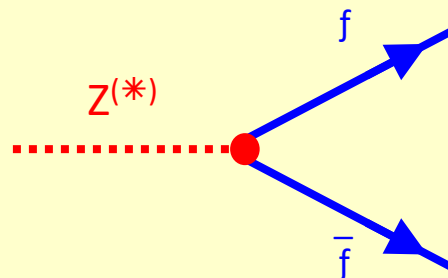
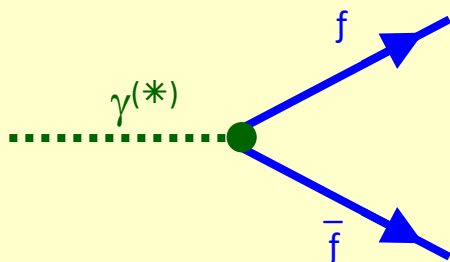

photon (γ)
(electromagnetism)

$$\mathcal{L}_F = -e \mathbf{J}_{\text{e.m.}}^\mu \mathbf{A}_\mu;$$

$$\mathbf{J}_{\text{e.m.}}^\mu = Q_f \bar{\Psi}_f \gamma^\mu \Psi_f.$$

[V]

neutral IVB (Z)
(neutral current)

$$\mathcal{L}_F = \frac{-e}{\sin\theta_w \cos\theta_w} J_{\text{nc}}^\mu Z_\mu;$$

$$J_{\text{nc}}^\mu = \bar{\Psi}_f \gamma^\mu \frac{g_V^f - g_A^f \gamma^5}{2} \Psi_f.$$

[combination $g_V^f V + g_A^f A$]

charged IVB (W^\pm)
(charged current)

$$\mathcal{L}_F = \frac{-e}{\sqrt{2} \sin\theta_w} J_{\text{cc}}^\mu \tau^\pm W_\mu^\pm;$$

$$J_{\text{cc}}^\mu = \bar{\Psi}_f \gamma^\mu \frac{1 - \gamma^5}{2} \Psi_{f'}.$$

[V - A]





vector properties of physical quantities :

- a 4-vector \vec{v} is the well-known quantity, which transforms canonically under a L-transformation \mathbb{L} (both boosts and rotations), and Parity \mathbb{P} in space :
 - space-time, 4-momentum, electric field, ...
- an axial vector \vec{a} transforms like a vector under \mathbb{L} , but gains an additional sign flip under \mathbb{P} :
 - cross-products $\vec{v} \times \vec{v}$, magnetic field, angular momentum, spin, ...
- a scalar s is invariant both under \mathbb{L} and \mathbb{P} :
 - [4-]dot-products $\vec{v} \cdot \vec{v}$ or $\vec{a} \cdot \vec{a}$, module of a vector, mass, charge, ...
- a pseudoscalar p is invariant under \mathbb{L} , but changes its sign under \mathbb{P} :
 - a triple product $\vec{v} \cdot \vec{v} \times \vec{v}$;
 - a scalar product $\vec{a} \cdot \vec{v}$ between a vector

and an axial vector, e.g. the helicity^(*);

- a tensor \mathbf{t} is a quantity which also transforms canonically under \mathbb{L} and \mathbb{P} , with ≥ 2 dimensions :
 - the electro-magnetic tensor $F^{\mu\nu}$.

(*) the helicity h is the projection of the spin \vec{s} along the momentum \vec{p} :

$$h = \frac{\vec{s} \cdot \vec{p}}{|\vec{s}| \cdot |\vec{p}|}$$



Q. : this "parity violation" does NOT happen. Why ?



References

1. [BJ, 11], [YN1, 15], [YN2, 6.1-6.2];
2. Fermi theory : [FNSN1, 6];
3. the weak interactions : [MQR, 15] and [IE, 9-10];
4. π and μ decay : Garwin et al. (Lederman) Phys.Rev. 105 (1957) 1415, Anderson et al, Phys.Rev. 119 (1960) 2050.
5. modern β -decays : Severijns et al., Rev.Mod.Phys. 78 (2006) 991.
6. modern hyperon decays : Cabibbo et al., Ann.Rev.Nucl.Part.Sci. 53 (2003) 39.

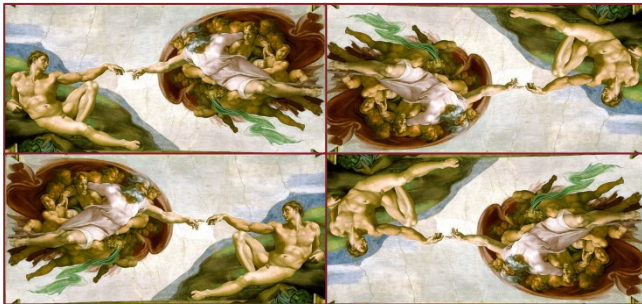



SAPIENZA
UNIVERSITÀ DI ROMA

End of chapter 4